

www.beta-tools.it

 **Beta**

Action



Promozione
valida dal 18/01/2016
al 15/12/2016
prezzi netti I.V.A. esclusa

RSC 55

RACING SYSTEM

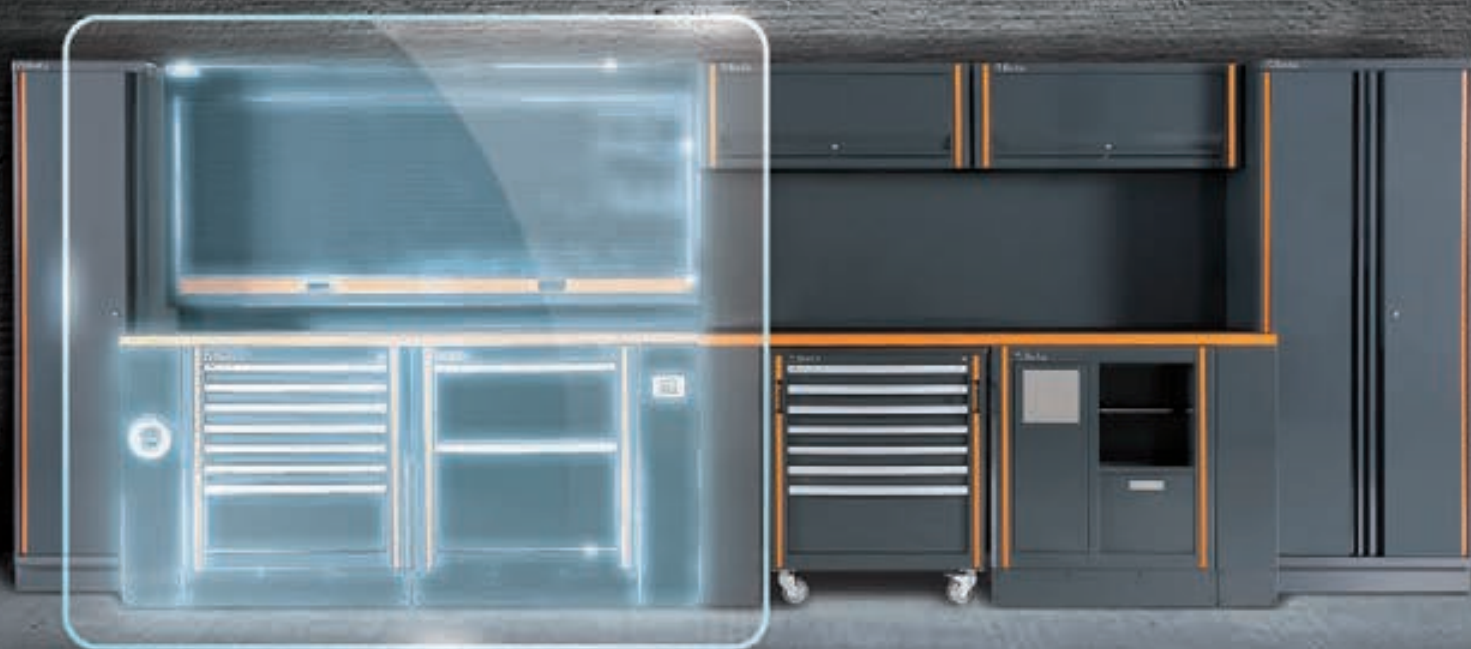

CSS B-PRO + CSS P7 + CSS P5P + CSS P2

PAG

31BM/D6	35	952/D7	22	1500...	40	1932B10	83	7525	96
38/B6	35	960AD/TP2	56	1501...	40	1933I	82	7526	96
42INOX/SC9	47	960EPC	60	1517...	40	1937...	82	7815N	95
42	20	960KC-M8/9/10	60	1530/C5	68	1940E10	83	7816BL	95
55/SP7	20	960KI	61	1545/C5M	41	1946C4,8	81	7816G	95
90/S7	20	960KPC	60	1547/C6	41	2080/V12	11	7840BL	91
96/BGS7	23	960PI/P	61	1550/2	70	2115PL-MQ32	46	7849BL	91
96BPC/SC9	24	961D...	55	1567	70	3002	77	7860E	93
96LBP/SC9	24	961P...	55	1569/A	67	3003	77	7861E	93
96/SC9	24	971/C8	69	1569/F	67	3007	76	7863E	93
96T/S5P	23	971TSP	69	1606A/C9	44	3008	76	7865E	93
97BTX/SC8	24	1009L/DP	32	1609B	44	3009	77	7867E	93
97TTX/S6	23	1031/S4	33	1651DGT...	39	3010T...	70	7869E	93
111...	22	1047...	33	1692...	39	3012C	64	7870E	94
142C/A12	21	1048	33	1695XS	39	3014SAR	74	7871E	94
142/SC9I	21	1057A	32	1696B...	39	3025...	73	7873E	94
142SN/SC9	21	1128BAX	36	1719BMA8/S5	36	3026...	74	7875E	94
192/S2	21	1130BMX	36	1740B...	48	3026/SP	74	7877E	94
334	42	1149F	44	1741U	48	3027...	75	7879E	94
342	42	1169BM/D3	32	1749AC	48	30302T	71	7900E	92
351C	42	1169MQ/D2	46	1750500	48	3061/2T	73	7901E	92
360...	43	1203/D...	34	1756D	49	3063/2,5T	71	7903E	92
378...	43	1207TX/D7	34	1758A	65	3065/40-20T	72	7905E	92
388C/C8	43	1243/D7	34	1758VT	62	3067/70-13T	72	7907E	92
412/SP19P	38	1256/C36-2	44	1759HD/3	63	5927VU/M	3	7909E	92
415CO/SP19A	38	1257LPH/S8	45	1759HD/TRUCK	63	5988...	15,16	C04TSS/7	47
425P/SP3	38	1263/D...	34	1759TT	63	7042LCD	50	C4	12
429/C7	38	1267TX/D7	34	1760/OHM	45	7200PN	87	C5	12
437K/16	68	1273MQ/D6	46	1760PA/80	54	7201PN	87	C6T	12
437K/33	62	1293/D8	34	1760PA/AC-DC	54	7210PB	87	C7	13
446/C110	38	1293INOX/D8	47	1760/RMS	45	7211PG	87	C8	13
560/C...	31	1368	66	1770BM	37	7220PE	86	C10	14
599DGT...	31	1368G/K400	66	1771	37	7221PE	86	C10S	13
601C	31	1370...	35	1777T	37	7224PE	86	C11	14
606...	30	1390...	35	1778SCL	37	7235B	85	C12	14
667N...	30	1392...	35	1778SOS	37	7236B	85	CP15...	11
720MRC	69	1428/SB11	41	1834P...	51	7241C	84	C20L	11
860/58K	25	1462/KD	61	1836	51	7243C	84	C23ST	6
860/C27	25	1464AP	56	1837N	51	7245B	84	C24S..	6
860MIX/A10	25	1464IC	56	1838/11LED	53	7246B	84	C24SA...	7
862F/A7	25	1464T	56	1838FLASH	52	7248G	85	C24SA-XL...	8
900/58	26	1471M/C22	68	1838UV/S2	52	7249G	85	C24SL...	8
900/C12M	28	1473P	68	1842LED...	53	7250NKK	89	C27S	3
900/C12MR	27	1477/C10	62	1846LED...	53	7251NKK	89	C28	9
900/C39	28	1479/B27	66	1860...	50	7252NKK	90	C39...	4,5
900/C39-R	26	1480	64	1870	49	7253NKK	90	C41H	2
902A/C22	29	1482	64	1873	49	7258NKK	89	C42H	2
910/58	26	1493/C19	66	1877	65	7259NKK	89	C51	10
910A/C16	28	1497/C23	57	1877A	65	7293NG	90	C56	10
910A/C16HR	27	1497/C94	54	1884	67	7294NG	90	C56W	10
920/58	26	1497RC	54	1901...	83	7310BKK	86	C59A	9
920A/C17M	29	1498...	59	1921I	81	7313B	88	M10-M230	16,17
920A/C17MR	27	1498A...	57,58	1927...	78	7313G	88	T10-T91	18
928A/C12	29	1498MN/12	59	1927AN	81	7316N	88	T92-T239	19
944BX/D6	22	1498ST/TB	58	1928...	79	7323M	88		
951/S6	23	1498TB/12	58	1930...	80	7505M	96		



C41H

041000002

~~€ 420,00~~
€ 238,00

21 kg



Trolley portautensili a 2 moduli in lamiera d'acciaio

- 2 moduli separabili:
 - 1 cestello superiore,
 - 1 modulo con 2 cassetti altezza 95 mm,
 - 1 cassetta portautensili estraibile in materiale plastico altezza 66 mm e 1 cassetto altezza 295 mm
- Portaminuterie integrato
- Impugnatura con manico telescopico in alluminio
- Predisposizione per lucchetto
- Serratura centralizzata per il modulo inferiore
- Cassetto inferiore con doppia guida telescopica
- Ruote di grosso diametro \varnothing 160 mm



825 mm
335 mm
536 mm

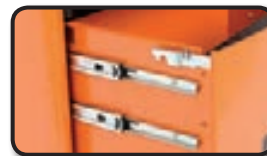

C42H

042000002

~~€ 298,00~~
€ 168,00

14 kg

Trolley portautensili a 3 moduli sovrapponibili

- 3 moduli separabili:
 - 1 cestello superiore, altezza 220 mm
 - 1 modulo portautensili centrale, altezza 180 mm
 - 1 modulo portautensili inferiore con ruote, altezza 330 mm
- Può essere utilizzato solamente con 2 moduli



730 mm
345 mm
545 mm



Cestello superiore con vano portaoggetti interno e 3 portaminuterie integrati nel coperchio



Manico telescopico regolabile in 3 posizioni.



Sistema di sgancio rapido dei moduli: agevole e veloce accesso a tutti i diversi scomparti portautensili.



Ruote di grosso diametro (\varnothing 160 mm)

Struttura in lamiera e materiale plastico

C27S

Contenitori



C27S

027000201

€ 495,00
€ 285,00

20 kg

Carrello portautensili richiudibile per interventi esterni, vuoto

- Struttura in lamiera
- Carrello richiudibile con colonnine ribaltabili per permettere un agevole trasporto
- 2 cassetti 588x277 mm montati su guide telescopiche che permettono l'apertura in due sensi
- Ampio vano portaoggetti inferiore 588x277x220 mm
- 2 ruote fisse Ø 160 mm e 2 ruote piroettanti con freno Ø 100 mm
- Piano di lavoro termoplastico con 6 vaschette portaminuterie integrate
- Chiusura centralizzata.
- Predisposizione per l'alloggiamento di separatori per cassetto e termoformati portautensili MC

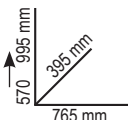

n°	h	max
2	70 mm	20 kg

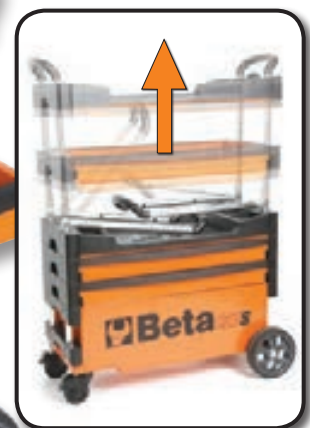

Trasportabile su veicolo

novità

5927 VU/M

059270021

€ 760,00
€ 440,00



Assortimento di 108 utensili in termoformato morbido per carrello C27S



MC10



MC20



039000001
039000002
039000003

C39/7

€ 1.250,00
€ 695,00

61 kg

Cassettiera mobile con 7 cassetti

da 588x367 mm montati su guide telescopiche a sfera

- Serratura di sicurezza centralizzata frontale
- Piano di lavoro termoplastico
- 4 ruote ø 125 mm 2 fisse e 2 girevoli (1 con freno)
- Portaflaconi laterali e posteriori integrati
- Portacarta integrato
- Piano dei cassetti protetto da tappetini di gomma espansa



Struttura in lega di alluminio:
**+RESISTENZA
+LEGGEREZZA**



Ruote con nucleo in acciaio

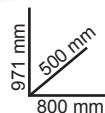

n°	h	max
5	70 mm	30 kg
1	140 mm	35 kg
1	210 mm	35 kg



039000031
039000032
039000033

C39/6

€ 1.180,00
€ 655,00

59 kg

Cassettiera mobile con 6 cassetti

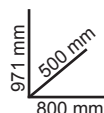

n°	h	max
4	70 mm	30 kg
1	140 mm	35 kg
1	280 mm	40 kg



039000041
039000042
039000043

C39/8

€ 1.330,00
€ 735,00

64 kg

Cassettiera mobile con 8 cassetti

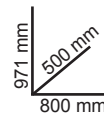

n°	h	max
6	70 mm	30 kg
2	140 mm	35 kg

29 kg

039000101
039000102
039000103

C39T

€ 790,00
€ 445,00

Cassettiera portatile con 4 cassetti

da 588x367 mm, montati su guide telescopiche a sfera



n°	h	max
4	70 mm	30 kg

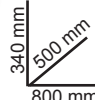

Caratteristiche tecniche

- Piano di lavoro in legno multistrato
- Serratura di sicurezza centralizzata frontale
- 4 ruote Ø 125 mm 2 fisse e 2 girevoli (una con freno) con copertura a vista
- **Modulo con 7 cassetti da 588x367 mm**, montati su guide telescopiche a sfera:
- 6 cassetti altezza 70 mm 1 cassetto altezza 240 mm
- Piano dei cassetti protetto da tappetini di gomma espansa
- Sistema di apertura posizionato su tutta la lunghezza del cassetto
- Frontalino del cassetto in alluminio

☎ 039390001

☎ 039390002

☎ 039390003

C39SM

~~€ 1.990,00~~
€ 1.150,00

125 kg

Cassettiera speciale mobile tipo Racing SM

Modulo di servizio

- Cestino portarifiuti integrato
- Vano portacarta per rotoli integrato
- 1 cassetto portaoggetti 380x305x270 mm



Racing SM

1200 kg



980 mm
500 mm
1500 mm

n°	h	max
6	70 mm	30 kg
1	240 mm	45 kg



☎ 039390101

☎ 039390102

☎ 039390103

C39MD

~~€ 2.050,00~~
€ 1.190,00

123 kg

Cassettiera speciale mobile Racing MD

Modulo con 2 cassetti da 588x367x270 mm e 588x367x380 mm

- montati su guide telescopiche a sfera
- Piano dei cassetti protetto da tappetini di gomma espansa
- Sistema di apertura posizionato su tutta la lunghezza dei cassettoni
- Frontalino dei cassettoni in alluminio



Racing MD

1200 kg



980 mm
500 mm
1500 mm

n°	h	max
6	70 mm	30 kg
1	240 mm	45 kg



024002071

024002072

024002073

C245/7

€ 715,00
€ 405,00

58 kg

Cassettiera mobile con 7 cassetti

- da 588x367 montati su guide telescopiche a sfera
- Piano di lavoro in ABS ad alta resistenza
 - Serratura di sicurezza centralizzata frontale
 - 4 ruote Ø 125 mm 2 fisse e 2 girevoli (1 con freno)
 - Portaflaconi laterale integrato
 - Piano dei cassetti protetto da tappetini di gomma espansa



Frontalino in Nylon ad alta resistenza



Ruote con nucleo in acciaio

955 mm
445 mm
740 mm



n°	h	max
5	70 mm	25 kg
1	140 mm	30 kg
1	210 mm	30 kg

024002061

024002062

024002063

C245/6

€ 660,00
€ 370,00

55 kg

Cassettiera mobile con 6 cassetti



955 mm
445 mm
740 mm

n°	h	max
4	70 mm	25 kg
1	140 mm	30 kg
1	280 mm	35 kg

024002081

024002082

024002083

C245/8

€ 770,00
€ 440,00

61 kg

Cassettiera mobile con 8 cassetti



955 mm
445 mm
740 mm

n°	h	max
6	70 mm	25 kg
2	140 mm	30 kg

023000521

023000522

023000523

C23ST

€ 490,00
€ 280,00

36 kg

Cassettiera portatile con 5 cassetti

- da 588x367 mm, montati su guide telescopiche a sfera
- Serratura centralizzata frontale
 - Kit opzionale 4 ruote + maniglione (2300ST/KIT)



454 mm
445 mm
740 mm

n°	h	max
5	70 mm	25 kg



C245A

Antiribaltamento

sistema antiribaltamento:
non consente l'apertura contemporanea
di più cassetti

800
kg



**Frontalino
in Nylon
ad alta resistenza**



**Ruote
con nucleo
in acciaio**

955 mm
445 mm
740 mm



024002171
024002172
024002173

C245A/7

~~€ 750,00~~
€ 430,00

58
kg

**Cassettiera mobile
con 7 cassetti,
con sistema antiribaltamento**

da 588x367 montati su guide
telescopiche a sfera

- Piano di lavoro in ABS ad alta resistenza
- Serratura di sicurezza centralizzata frontale
- 4 ruote Ø 125 mm
2 fisse e 2 girevoli (1 con freno)
- Portaflaconi laterale integrato
- Piano dei cassetti protetto da tappetini di gomma espansa



n°	h	max
5	70 mm	25 kg
1	140 mm	30 kg
1	210 mm	30 kg

novità



024002161
024002162
024002163

C245A/6

~~€ 695,00~~
€ 395,00

55
kg

**Cassettiera mobile con 6 cassetti
con sistema antiribaltamento**



955 mm
445 mm
740 mm

n°	h	max
4	70 mm	25 kg
1	140 mm	30 kg
1	280 mm	35 kg

novità



024002181
024002182
024002183

C245A/8

~~€ 810,00~~
€ 465,00

61
kg

**Cassettiera mobile con 8 cassetti
con sistema antiribaltamento**



955 mm
445 mm
740 mm

n°	h	max
6	70 mm	25 kg
2	140 mm	30 kg



024002271

024002272

024002273

C245A-XL/7

€ 940,00
€ 535,00

84 kg

Cassettiera mobile con 7 cassetti con sistema antiribaltamento, modello lungo

- 7 cassetti da 882x367 mm, montati su guide telescopiche a sfera
- Piano di lavoro in ABS ad alta resistenza, con 6 vaschette portaminuterie
- Frontalino in nylon ad alta resistenza, con porta-etichette integrato
- Piano dei cassetti protetto da tappetini di gomma espansa
- 4 ruote con nucleo in acciaio Ø 125 mm: 2 fisse e 2 girevoli (1 con freno)
- Serratura di sicurezza centralizzata frontale
- Portaflaconi laterale integrato

1000 kg



Frontalino in Nylon ad alta resistenza

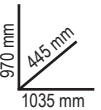

882 mm



n°	h	max
5	70 mm	30 kg
1	140 mm	35 kg
1	210 mm	35 kg

novità



024002281

024002282

024002283

C245A-XL/8

€ 1.015,00
€ 580,00

88 kg

Cassettiera mobile con 8 cassetti con sistema antiribaltamento, modello lungo

n°	h	max
6	70 mm	30 kg
2	140 mm	35 kg

può contenere 6 TERMOFORMATI

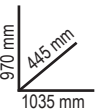

1100 kg



024002101

024002102

024002103

C245L

€ 1.050,00
€ 598,00

80 kg

Cassettiera mobile con 7 cassetti e ripiani laterali

- 7 cassetti da 588x367 mm, montati su guide telescopiche a sfera
- Piano di lavoro in legno multistrato con fori per l'accollocazione di una morsa 1599F/100 da ordinare separatamente
- 3 portaflaconi e portacarta integrati
- Vano laterale con ripiano regolabile in altezza
- Serratura di sicurezza centralizzata frontale
- 4 ruote Ø 125 mm: 2 fisse e 2 girevoli (2 con freno)
- Piano dei cassetti protetto da tappetini di gomma espansa



Ruote con nucleo in acciaio

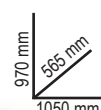

n°	h	max
5	70 mm	25 kg
1	140 mm	30 kg
1	210 mm	30 kg

028000301

028000302

028000303

C28~~€ 1.900,00~~**€ 1.080,00****130 kg****Carrello SuperTank con piano di lavoro e 10 cassetti**

da 588x367 mm, montati su guide telescopiche a sfera

- Piano di lavoro in legno multistrato con fori per la collocazione di una morsa 1599F/150 da ordinare separatamente
- Sistema rapido e sicuro per l'apertura e chiusura dei cassetti con frontalino in nylon ad alta resistenza
- Vano passante altezza 135 mm con base ricoperta in materiale plastico
- 4 portaflaconi: 2 frontali e 2 posteriori
- Vano laterale con antina di chiusura a scomparsa con serratura
- 4 ruote ad alta portata Ø 150 mm: 2 fisse e 2 girevoli con freno
- 6 vaschette portaminuterie laterali
- Piano dei cassetti protetto da tappetini di gomma espansa



945 mm
800 mm
1235 mm

n°	h	max
8	70 mm	25 kg
2	210 mm	30 kg



059000001

059000021

059000041

C59A~~€ 1.230,00~~**€ 698,00****115 kg****Banco con 1 cassetiera da 6 cassetti**

- 6 cassetti 588x367 mm, montati su guide telescopiche a sfera
- Ripiano in legno multistrato con fori per la collocazione di una morsa 1599F/125 (da ordinare separatamente)
- Piano dei cassetti protetto da tappetini di gomma espansa
- Cassettiere predisposte per l'inserimento di termoformati
- Frontalino dei cassetti in nylon ad alta resistenza
- Serratura di sicurezza centralizzata frontale
- Ripiano inferiore portaoggetti
- Predisposizione per portacarta (2400S-R/PC) e portaflaconi (2400S/PF) da ordinare separatamente

**1500 kg**

n°	h	max
4	70 mm	25 kg
1	140 mm	30 kg
1	280 mm	35 kg

930 mm
700 mm
2000 mm



novità

056000251

056000252

056000253

C56W

~~€ 870,00~~

€ 495,00

Banco da lavoro con piano di lavoro in legno

- Piano di lavoro in legno multistrato (spessore 40 mm)
- Struttura in acciaio con 6 gambe di sostegno
- Abbinabile alla parete C57P (non fissabile al piano di lavoro)
- Due cassetti dotati di serratura
- Predisposizione per il fissaggio al pavimento



056000201
056000202
056000203

C56

~~€ 685,00~~

€ 395,00

Banco da lavoro

- Piano di lavoro in lamiera verniciata con bordo perimetrale
- Struttura in acciaio con 6 gambe di sostegno
- Abbinabile alla parete C57P (non fissabile al piano di lavoro)
- Due cassetti dotati di serratura
- Predisposizione per il fissaggio al pavimento

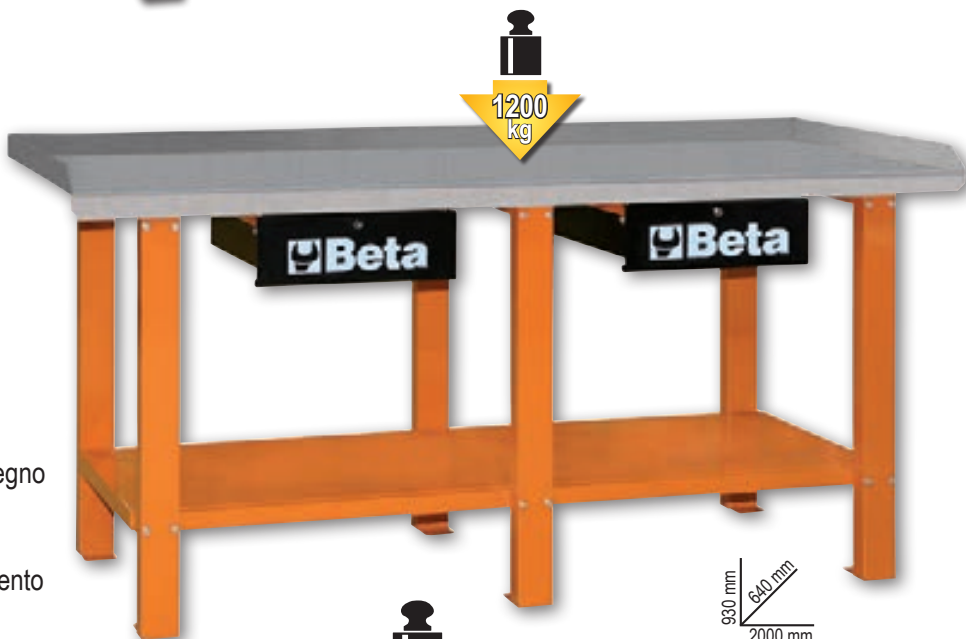

051000001

051000002

051000003

C51

~~€ 195,00~~

€ 110,00

21 kg

Carrello

- 3 ripiani ricoperti in gomma millerighe antiscivolo
- Capacità di carico statico: 200 kg (distribuito su 3 ripiani)
- Doppia possibilità di fissaggio del ripiano centrale
- 4 ruote Ø 100 mm: 2 fisse e 2 girevoli (1 con freno)



C20L

021200002

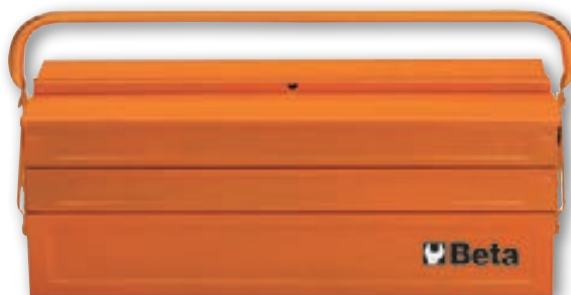
~~€ 61,00~~
€ 35,00**Cestello estendibile
a 5 scomparti, vuoto
in lamiera**

≡ 550x200x210 mm

**novità****2080/V12**

020800000

~~€ 42,00~~
€ 24,00**Valigia organizer
con 12 vaschette
asportabili, vuota**Vaschette portaminuterie asportabili,
richiudibili e trasparenti
per un' immediata
riconoscibilità del contenuto.
Possono essere agganciate
alla cintura

≡ 300x330x145 mm

**CP15**

021150201

~~€ 34,00~~
€ 19,50**Cestello in materiale plastico
con contenitore e vaschette
portaminuterie asportabili, vuoto**

- 1 vaschetta portaminuterie integrata nel coperchio
- 2 vaschette portaminuterie asportabili con divisori regolabili
- 1 contenitore interno con divisori regolabili
- Portata massima: 30 kg

≡ **445**x240x250 mm**CP15L**

021150202

~~€ 45,00~~
€ 26,00**Cestello modello lungo
in materiale plastico
con contenitore e vaschette
portaminuterie, vuoto**

- 3 vaschette portaminuterie integrate nel coperchio con divisori regolabili
- 1 contenitore interno con divisori regolabili
- Portata massima: 30 kg

≡ **558**x277x270 mm

C4

021040000

~~€ 73,00~~
€ 42,00

Secchiello portautensili in tessuto tecnico, vuoto

- Pannello portautensili interno estraibile
- Tasche ed elastici portautensili sia esterni che interni
- Base rigida impermeabile con piedini in gomma
- Fornito di tracolla

≡ 360x330x260x mm



C5

021050000

~~€ 90,00~~
€ 52,00

Zaino portautensili in tessuto tecnico, vuoto

- Pannello portautensili interno removibile
- 6 tasche esterne
- 2 capienti tasche interne
- Base in materiale plastico resistente all'acqua
- Doppio laccetto di sicurezza per fissare lo zaino sulle spalle

≡ 500x400x180 mm



C6T

021060010

~~€ 150,00~~
€ 87,00

Zaino portautensili in tessuto tecnico con ruote, vuoto

- Manico telescopico di trasporto
- Ruote integrate nella struttura con copertura anti-polvere per l'impiego come zaino
- 2 pannelli portautensili removibili
- 5 tasche esterne
- Capiente tasca interna porta pc

≡ 480x370x220 mm



C7

021070000

~~€ 168,00~~
€ 97,00**Borsa portautensili in tessuto tecnico, vuota**

- 2 pannelli interni portautensili removibili
- Tasca porta PC interna
- 2 tasche esterne frontali
- Fondo interno in materiale plastico con divisori removibili

440x370x170 mm

**C8**

021080000

~~€ 175,00~~
€ 99,00**Trolley portautensili in tessuto tecnico, vuoto**

- Manico telescopico di trasporto
- 2 pannelli interni portautensili removibili
- 2 tasche esterne frontali
- Tasca porta pc interna
- Predisposizione per l'alloggiamento del cestello C10S (da ordinare separatamente)

470x370x280 mm

**C10S**

021100001

~~€ 81,00~~
€ 47,00**Cestello portautensili in tessuto tecnico, vuoto**

- Struttura rigida
- Doppio fondo. Il fondo si può rimuovere per aumentare la capienza della borsa
- Manico inclinabile per facilitare l'accesso agli utensili
- Elastici portautensili e tasche sia interne che esterne
- Fodero di copertura
- Vaschetta portaminuterie inclusa nel doppio fondo

420x220x250 mm



C10S

C8

C10

021100000

~~€ 105,00~~
€ 61,00

Cestello portautensili in tessuto tecnico, vuoto

- Struttura rigida
- Doppio fondo. Il fondo si può rimuovere per aumentare la capienza della borsa
- Manico inclinabile per facilitare l'accesso agli utensili
- Elastici portautensili e tasche sia interne che esterne
- Fodero di copertura
- Vaschetta portaminuterie inclusa nel doppio fondo



520x220x250 mm



C11

021110000

~~€ 64,00~~
€ 37,00

Cestello portautensili in tessuto tecnico, vuoto

- Base rigida in materiale plastico resistente all'acqua
- Elastici e tasche portautensili sia interne che esterne
- Buste portadocumenti integrate nel doppiofondo del coperchio

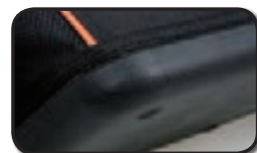

400x240x220 mm

C12

021120000

~~€ 143,00~~
€ 83,00

Borsa portautensili per elettricisti in tessuto tecnico, vuota

- Pannello interno portautensili estraibile
- Elastici portautensili e capienti tasche sia interne che esterne
- Base rigida impermeabile con piedini in gomma
- Predisposizione per essere utilizzata con il trolley C8



500x370x270 mm

La borsa si apre anteriormente per facilitare l'accesso agli utensili sul luogo di lavoro



Assortimenti in termoformato



L 059880410
 XL 059880411

5988VA/T

~~€ 1.350,00~~
€ 780,00

Assortimento di 107 utensili, in termoformato rigido



T199 T202 T80



T145 T153 T131 T234



T52 T33 T15 T16



T63 VP5



L 059880420
 XL 059880421

5988VI/T

~~€ 1.215,00~~
€ 705,00

Assortimento di 108 utensili, in termoformato rigido



T199 T202 T80



T145 T153 T131 T234



T52 T33 T15 T16



T236 T289 VP4 VP4



L 059880440
 XL 059880441

5988U/TP

~~€ 975,00~~
€ 565,00

Assortimento di 90 utensili, in termoformato rigido

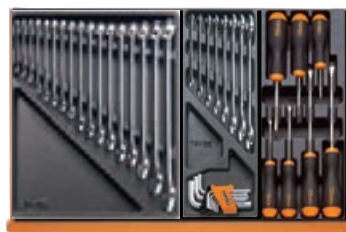

T10 T33 T220



T83 T145 T153



T132 T234 T52 T55



L 059880428
XL 059880429

5988U/MP

~~€ 986,00~~
€ 570,00

Assortimento di 91 utensili,
in termoformato morbido



M15 M33 M199 M202



M50



M83

M132 M153 M234 M145



novità

L 059880430
XL 059880431

5988 U6/MP

~~€ 2.330,00~~
€ 1.350,00

Assortimento di 214
utensili, in termoformato
morbido



M10



M30



M210



M230

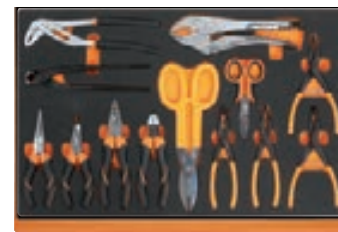

M130

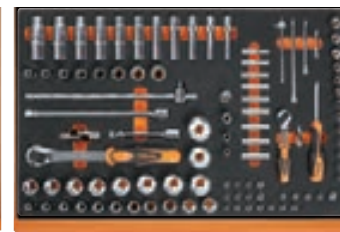

M100

Termoformati morbidi

novità

M10

024500010

~~€ 332,00~~
€ 193,00



42 6-7-8-9-10-11-12-13-14-15-16-17-18-19-
20-21-22-24-27-30-32-36 mm

M30

024500030

~~€ 300,00~~
€ 175,00



55 6x7-8x9-10x11-12x13-14x15-16x17-18x19-20x22
21x23-24x27-30x32 mm
90 6x7-8x9-10x11-12x13-14x15-16x17-18x19-20x22
21x23-24x27-30x32 mm
96BPC/SC9 1,5-2-2,5-3-4-5-6-8-10 mm

M60

024500060

~~€ 282,00~~
€ 165,00



- 96T 2-2.5-3-4-5-6-7-8-10 mm
- 97BTX/SC8 T9-T10-T15-T20-T25-T27-T30-T40
- 944BX 5-6-7-8-10-13 mm

M121

024500121

~~€ 918,00~~
€ 535,00

12"

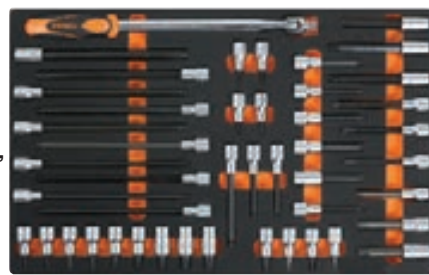

- 920BP 5L-6L-8L-10L-5XL-6XL-8XL mm
- 920TX T20-T25-T27-T30-T40-T45L-T50L-T55L-T60L-T70L
- 920XZN 4-5-6-6L-8-8L-10-10L-12-12L-14-14L-16-18 mm
- 920ES 7-9-10-11-12L-14L-16L-7XL-9XL-10XL-11XL-12XL-14XL-16XL mm
- 920/36A

M63

024500063

~~€ 251,00~~
€ 147,00



- 952 7-8-10-12-13-14-17-19 mm

M130

024500130

~~€ 311,00~~
€ 180,00



- 1032 180 mm
- 1034 170 mm
- 1036 175 mm
- 1038 175 mm
- 1048 250 mm
- 1052 240 mm
- ⚡ 1082BM 160 mm
- 1098 220 mm
- 1112 250 mm
- 1128BM
- 1150BM 180 mm
- 1166BM 160 mm
- 1168BM 160 mm

M100

024500100

~~€ 943,00~~
€ 548,00

12" 14"

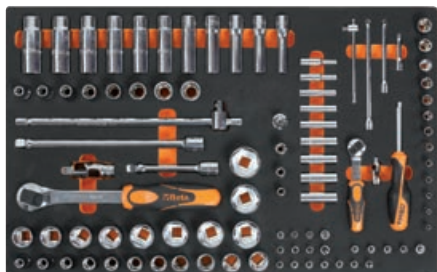

895/1 - 895/3 - 895/6

- 900 4-4,5-5-5,5-6-7-8-9-10-11-12-13-14 mm

- 900L 5-6-7-8-9-10-11-12-13 mm

- 900ME 3-4-5-6-7 mm

- 900LP 0,8x4-1x5,5-1,2x6,5-1,2x8 mm

- ⊕ 900PH PH1-PH2-PH3-PH4

- 900TX T10-T15-T20-T25-T27-T30-T40

- 900/20 50 mm - 900/20L 100 mm

- 900/21 150 mm

- 900/25 - 900BG/30 - 900/42

- ⊗ 900/55

- 920A 8-10-11-12-13-14-15-16-17-18-19-20-21-22-23-24-26-27-28-30-32 mm

- 920/15 - 920/25

- 920AN/125 125 mm

- 920AN/250 250 mm

- 920/42

- ⊗ 920/55

- 920FTX 10-12-14-16-18-20-22-24 mm

- 920AL 10-12-13-14-15-16-17-18-19-21-22 mm

M210

024500210

~~€ 153,00~~
€ 89,00



- 1201 2,5x50-3x75-4x100-5,5x125-6,5x150-8x200 mm
- 1201N 4x30 mm
- ⊕ 1202 PH0x60-PH1x80-PH2x100-PH3x150 mm

- ⊕ 1202N PH1X30 mm
- 1207TX T6-T7-T8-T9-T10-T15-T20-T25-T27-T30-T40-T45

- 1253

M120

024500120

~~€ 1.012,00~~
€ 588,00

12"



- 920A 10-11-12-13-14-15-16-17-18-19-20-21-22-24-26-27-30-32 mm

- 920AN/125 125 mm

- 920AN/250 250 mm

- 920/25 - 920/42

- 920AL 10-12-13-14-15-16-17-18-19-22-24-27-30-32 mm

- 920FTX 10-12-14-16-18-20-22-24 mm

- ⊗ 920/55

- 920PE 5-5L-6-6L-7-7L-8-8L-10-10L-12-12L-14-14L

- 920TX T20-T25-T27-T30-T40-T45-T50-T55-T60-T20L-T25L-T27L-T30L-T40L-T45L-T50L

M230

024500230

~~€ 291,00~~
€ 169,00



- 30 Ø 2-3-4 mm
- 31 Ø 2-3-4-5-6-8 mm
- 32 Ø 4 mm
- 34 150 mm
- 35 200-250 mm
- 36 125 mm
- 1370 500 g
- 1390 Ø 35 mm
- 1692 3 m

1712

- 1719BMA/Q 200 mm

- ▲ 1719BMA/T 200 mm

- 1719BMA/P 200 mm

- ▶ 1719BMA/M 200 mm

- 1719BMA/R 200 mm

1737

- 1771 18 mm

T10
024240010
~~€ 203,00~~
€ 119,00



42 6-7-8-10-11-12-13-14
16-17-18-19-21-22-24-27-30 mm

T15
024240015
~~€ 154,50~~
€ 90,00



42 6-7-8-9-10-11-12-13-14
15-16-17-18-19-20-21 mm

T16
024240016
~~€ 110,00~~
€ 64,00



42 22-24-27-30-32 mm

T31
024240031
~~€ 162,50~~
€ 95,00



31 Ø 2-3-4-5-6 mm
32 Ø 4 mm
55 6x7-8x9-10x11
12x13-14x15
16x17-18x19
20x22-21x23
24x26-27x29
30x32 mm
○ 96N/SC9
1,5÷10 mm

T40
024240040
~~€ 76,50~~
€ 45,00



90 6x7-8x9-10x11-12x13
14x15-16x17-18x19 mm

T45
024240045
~~€ 233,00~~
€ 135,00



142 8-9-10-11-12-13-14
15-16-17-18-19 mm

T46
024240046
~~€ 276,00~~
€ 160,00



142SN 8-9-10-11-12-13-14
15-16-17-18-19 mm

T50
024240050
~~€ 127,00~~
€ 74,00



○ 96T 2-2,5-3-3,5-4-4,5-5-6-7-8-10 mm

T55
024240055
~~€ 72,00~~
€ 42,00



○ 97TTX T10-T15-T20 T25-T27-T30

T63
024240063
~~€ 244,50~~
€ 142,00



○ 952 7-8-10-12-13-14-17-19 mm

T83
024240083
~~€ 258,00~~
€ 152,00



○ 920A 10-11-12
13-14-15-16-17-18
19-20-21-22-23-24
26-27-30-32 mm
920/21 125 mm
920/22 255 mm
920/25
920/42 305 mm
920/55 Ⓢ 275 mm

12"

T85
024240085
~~€ 261,00~~
€ 152,00

1/4"



● 861LP 0,5x3-0,6x4,5-0,8x5,5-1x5,5-1,2x6,5-1,2x8-1,6x8 mm
○ 861PE 2-2,5-3-4-5-6-8-10 mm
⊕ 861PH PH0- PH1 - PH2 - PH3
⊕ 861PZ PZ1 - PZ2 - PZ3
○ 861TX T6-T7-T8-T9-T10-T15-T20-T25-T27-T30-T40
⊕ 861RTX T9-T10-T15-T20-T25-T27-T30-T40
⊕ 861TRW 1-2-3-4-5-6 mm
⊕ 861TQS 0-1-2-3-4-5-6-8 mm
● 861SP 4-6-8-10-12 mm
851SR 230 mm
○ 900 4-4,5-5-5,5-6-7-8-9-10-11-12-13-14 mm
900/21 150 mm 900/25 41 mm
900BG/30 176 mm 900/42 115 mm
Ⓢ 900/55 125 mm 194 1/4x5/16

T91
024240091
~~€ 171,00~~
€ 99,00



○ 900 4-4,5-5-5,5-6-7-8-9
10-11-12-13-14 mm
○ 900ME 2,5-3-4-5-6-8 mm
900/20 50 mm
900/21 150 mm
900/25
900BG/30 176 mm
900/42 115 mm
Ⓢ 900/55 125 mm

1/4"

T92
024240092
~~€ 206,00~~
€ 120,00



○ 910A 6-7-8-9-10-11-12
13-14-15-16-17-18
19-20-21-22 mm
910/21 125 mm
910/22 250 mm
910/25
910/42 210 mm
⊗ 910/55 200 mm
38"

T103
024240103
~~€ 237,00~~
€ 138,00



12" 14"
○ 900L 6-7-8-9-10-11-12 mm
○ 920AL 13-14-16-17-18-19
21-22-24-27 mm

T131
024240131
~~€ 81,00~~
€ 47,00



1084BM 160 mm
1150BM 180 mm
1166BM 160 mm

T145
024240145
~~€ 90,00~~
€ 53,00



○ 1032 180 mm
○ 1034 170 mm
● 1036 175 mm
● 1038 175 mm

T153
024240153
~~€ 56,00~~
€ 33,00



1048 250 mm
1052 240 mm

T199
024240199
~~€ 41,00~~
€ 24,00



● 1260 2,5x50 - 3x75
3,5x100 - 4x125 - 5,5x100
5,5x150-6,5x150 mm
Beta GRIP

T202
024240202
~~€ 38,00~~
€ 22,00



⊕ 1262 PH0x60
PH0x100 - PH1x80
PH1x120 - PH2x100
PH2x150 mm
Beta GRIP

T205
024240205
~~€ 57,00~~
€ 33,00



○ 1267TX
T6-T7-T8-T9
T10-T15-T20
Beta GRIP

T210
024240210
~~€ 29,50~~
€ 17,00



● 1201 2,5x50-3x75
3,5x100-4x125
5,5x100-5,5x150
6,5x150 mm
Beta EASY

T212
024240212
~~€ 31,50~~
€ 18,50



⊕ 1202 PH0x60-PH1x80
PH1x120-PH2x100
PH2x150-PH3x150 mm
Beta EASY

T215
024240215
~~€ 43,00~~
€ 25,00



○ 1207TX
T6-T7-T8-T9
T10-T15-T20
Beta EASY

T234
024240234
~~€ 68,50~~
€ 40,00



35 100-200 mm
1370 300 g
1390 ø 35 mm

T236
024240236
~~€ 68,50~~
€ 40,00



■ 1719BMA/Q 200 mm
▲ 1719BMA/T 200 mm
▭ 1719BMA/P 200 mm
▮ 1719BMA/M 200 mm
● 1719BMA/R 200 mm

T239
024240239
~~€ 93,00~~
€ 54,00



31BM ø 2-3-4-5
6-8 mm
32 ø 4 mm

42/SP15

000420078

~~€ 140,00~~

€ 79,50

Serie di 15 chiavi combinate con supporto

6-7-8-9-10-11-12-13-14-15
16-17-19-22-24 mm



55/SP7

000550167

~~€ 39,00~~

€ 22,50

Serie di 7 chiavi a forchetta doppie con supporto

6x7-8x9-10x11-12x13-14x15
16x17-18x19 mm



42/SC9I

000420087

~~€ 82,50~~

€ 47,50

Serie di 9 chiavi combinate con supporto compatto

8-10-11-12-13-14-15-17-19 mm



90/S7

000900163

~~€ 69,00~~

€ 39,50

Serie di 7 chiavi poligonali doppie curve

6x7-8x9-10x11-12x13-14x15-16x17-18x19 mm



Chiavi di manovra

142/SC9I

001420087

~~€ 165,50~~
€ 95,00

Serie di 9 chiavi combinate a cricchetto reversibile con supporto compatto

8-10-11-12-13-14-15-17-19 mm



142SN/SC9

001420259

~~€ 198,00~~
€ 114,00

Serie di 9 chiavi combinate a cricchetto snodate con supporto compatto

8-10-11-12-13-14-15-17-19 mm



192/S2

001920070

~~€ 50,00~~
€ 29,00

Serie di 2 chiavi poligonali a cricchetto reversibile



8 misure in 2 chiavi

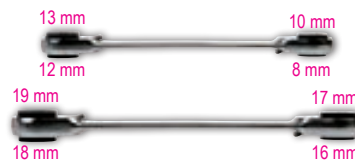

142C/A12

001420175

~~€ 170,00~~
€ 98,00

Serie di 12 chiavi combinate corte diritte a cricchetto in astuccio

8-9-10-11-12-13-14-15 -16-17-18-19 mm



III/150

001110015

~~€ 19,50~~
€ 11,00

L 150 mm A max 24 mm

III/200

001110020

~~€ 23,50~~
€ 13,50

L 200 mm A max 28 mm

**Doppia lettura
mm - pollici**

**Chiavi regolabili a rullino cromate
con scala graduata**

- Apertura della ganaschia mobile con rotazione destrorsa del rullino
- Scala millimetrata e in pollici



III/250

001110025

~~€ 28,50~~
€ 16,50

L 250 mm A max 34 mm

III/300

001110030

~~€ 38,00~~
€ 22,00

L 300 mm A max 35 mm

944BX/D6

009440056

~~€ 93,00~~
€ 54,00

**Serie di 6 chiavi a bussola esagonale
profonda tipo lungo**

○ 5-6-7-8-10-13 mm



952/D7

009520079

~~€ 183,00~~
€ 105,00

**Serie di 7 chiavi a T con
bussola esagonale snodata**

○ 7-8-10-12-13-14-17 mm



Chiavi maschio

96T/S5P

000960946

~~€ 47,50~~
€ 27,00



Serie di 5 chiavi
maschio esagonale
piegate con impugnatura

○ 2,5-3-4-5-6 mm



95I/S6

009510687

~~€ 95,50~~
€ 55,00



Serie di 6 chiavi a T
con tre estremità
maschio esagonale

○ 2,5-3-4-5-6-8 mm

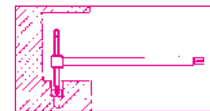

97TTX/S6

000970795

~~€ 67,50~~
€ 39,00



Serie di 6 chiavi maschio
piegate per viti con impronta Torx
con impugnatura

○ T10-T15-T20-T25-T30-T40



96/BGS7

000960367

~~€ 23,50~~
€ 13,50



Serie di 7 chiavi
maschio esagonale

○ 1,5-2-2,5-3-4-5-6 mm



96/SC9

000960374

~~€ 15,80~~

€ 9,00



Serie di 9 chiavi maschio esagonale piegate

○ 1,5-2-2,5-3-4-5-6-8-10 mm



supporto con sistema di bloccaggio delle chiavi

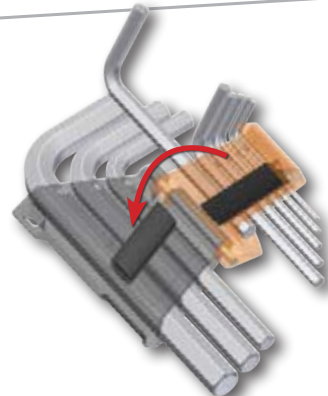

96BPC/SC9

000960354

~~€ 34,00~~

€ 16,90



Serie di 9 chiavi maschio esagonale piegate con un'estremità sferica

○ 1,5-2-2,5-3-4-5-6-8-10 mm



96LBP/SC9

000961354

~~€ 39,00~~

€ 22,00



Serie di 9 chiavi maschio esagonale piegate con un'estremità sferica

○ 1,5-2-2,5-3-4-5-6-8-10 mm



Modello extra lungo

+30%



97BTX/SC8

000970164

~~€ 61,00~~

€ 33,00



Serie di 8 chiavi maschio piegate con un'estremità sferica per viti con impronta Torx®

○ T9-T10-T15-T20-T25-T27-T30-T40

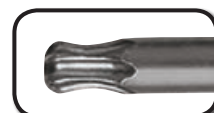

Inserti

860MIX/A10

008600900

~~€ 28,50~~
€ 16,00

- 860LP 0,5x3 - 1,0x5,5 - 1,2x6,5 mm
- 860PH PH1 - PH2 (x2) - PH3
- 860PZ PZ1 - PZ2 - PZ3
- 882M1 ○ 1/4" - ● 1/4"



Serie di 10 inserti colorati con portainseriti magnetico, in astuccio tascabile



novità

860/58K

008609884

~~€ 56,00~~
€ 32,50



• Avvicinamento rapido dell'inserto con la sola rotazione dell'impugnatura

Cricchetto portainseriti con impugnatura rotante



L'inserto si può inserire su entrambi i lati per avvitare o svitare

860/C27

008600880

~~€ 67,00~~
€ 38,00



Cricchetto interamente in acciaio

Serie di 25 inserti colorati con raccordo e cricchetto reversibile in astuccio tascabile

- 860LP 0,5x3-1,0x5,5-1,2x6,5 mm
- 860PE 2-2,5-3-4-5-6-mm
- 860PH PH1-PH2(x2)-PH3
- 860TX T6-T8-T10-T15-T20-T25-T30-T40
- 860PZ PZ1 - PZ2(2x) - PZ3
- 860/55 100 mm
- 892/0



862F/A7

008620950

~~€ 37,00~~
€ 21,50



Serie di 7 inserti a bussola esagonale magnetici, in astuccio tascabile

- 862F 5,5-6-7-8-10-12-13 mm





Cricchetto reversibile con impugnatura rotante

- Sistema di inversione a ghiera sulla testa del cricchetto
- Impugnatura bimatériale



Avvicinamento rapido del quadro con la sola rotazione dell'impugnatura

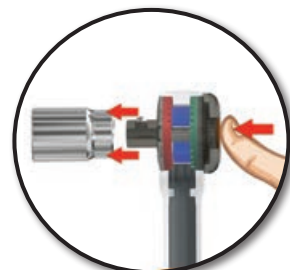

Pulsante di rilascio della bussola

900/58
009000884
~~€ 54,00~~
€ 31,50



1/4"

910/58
009100884
~~€ 59,00~~
€ 34,50



3/8"

920/58
009200926
~~€ 69,00~~
€ 39,50



1/2"

	L mm	Ø mm	A mm
900/58	126	28	28,5
910/58	222	37	38,5
920/58	281	42,5	45

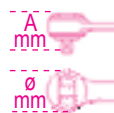

Ideale per operare in spazi ristretti

novità

900/C39-R

009000938

~~€ 177,00~~
€ 99,00

Assortimento di 11 chiavi a bussola esagonali, 21 inserti e 7 accessori
• Cricchetto reversibile con impugnatura rotante

	861LP	●	0,6x4,5-1,2x6,5-1,2x8 mm
	861PE	○	2,5-3-4-5-6 mm
	861PH	⊕	1-2-3
	861PZ	⊗	1-2-3
	861RTX	⊗	10-15-20-25-27-30-40 mm
	892/0		
	895/1		
	900	○	5-5,5-6-7-8-9-10-11-12-13-14 mm
	900/20		50 mm
	900/20L		100 mm
	900/25		
	900BG/30C		
	900/58		



1/4"

1/4"

150x95x50 mm

Beta
MUNI
360°



Chiavi a bussola

900/C12MR

009000962

€ 189,50

€ 109,00

1/4"

1/4"

Assortimento di 12 chiavi a bussola esagonali, 20 inserti per avvitatori e 7 accessori in termoformato morbido, in cassetta di lamiera



	861LP	●	0,5-0,8-1-1,2 mm
	861PE	○	3-4-5-6-8 mm
	861PH	⊕	PH0-PH1-PH2-PH3
	861TX	⊗	T8-T10-T15-T20-T25-T30-T40
	895/1		
	900	○	4-5-5,5-6-7-8-9-10-11-12-13-14 mm
	900/20		50 mm
	900/21		150 mm
	900/25		
	900/42		
	900BG/30		
	900/58	⊗	



350x150x50 mm

910A/C16HR

009100935

€ 229,50

€ 129,00

3/8"

Assortimento di 16 chiavi a bussola esagonali e 5 accessori in cassetta di lamiera

	910A	○	6-7-8-9-10-11-12-13-14 15-16-17-18-19-21-22 mm
	910/21		125 mm
	910/22		250 mm
	910/25		
	910/42		
	910/58	⊗	



335x145x60 mm

920A/C17MR

009200937

€ 275,00

€ 156,00

1/2"

Assortimento di 17 chiavi a bussola esagonali e 5 accessori in termoformato morbido, in cassetta di lamiera

	920A	○	10-11-12-13-14-15-16-17-18-19 20-21-22-24-27-30-32 mm
	920/21		125 mm
	920/22		255 mm
	920/25		
	920/42		
	920/58	⊗	



420x185x60 mm

900/C39

009000937

~~€ 156,00~~
€ 89,00



Assortimento di 11 chiavi a bussola esagonali, 21 inserti e 7 accessori in cassetta di plastica

	861LP	●	0,6x4,5-1,2x6,5-1,2x8 mm
	861PE	○	2,5-3-4-5-6 mm
	861PH	⊕	1-2-3
	861PZ	⊕	1-2-3
	861RTX	⊗	10-15-20-25-27-30-40 mm
	892/0		
	895/1		
	900	○	5-5,5-6-7-8-9-10-11-12-13-14 mm
	900/20		50 mm
	900/20L		100 mm
	900/25		
	900BG/30C		
	900/55	⊗	



Beta mini
con un'anima
GRANDE

150x95x50 mm

900/C12M

009000963

~~€ 171,50~~
€ 99,00



Assortimento di 12 chiavi a bussola esagonali, 20 inserti per avvitatori e 7 accessori in termoformato morbido, in cassetta di lamiera

	861LP	●	0,5-0,8-1-1,2 mm
	861PE	○	3-4-5-6-8 mm
	861PH	⊕	PH0-PH1-PH2-PH3
	861TX	⊗	T8-T10-T15-T20-T25-T30-T40
	895/1		
	900	○	4-5-5,5-6-7-8-9-10-11-12-13-14 mm
	900/20		50 mm
	900/21		150 mm
	900/25		
	900/42		
	900BG/30		
	900/55	⊗	

350x150x50 mm



910A/C16

009100936

~~€ 210,00~~
€ 121,00



Assortimento di 16 chiavi a bussola esagonali e 5 accessori in cassetta di lamiera

	910A	○	6-7-8-9-10-11-12-13-14 15-16-17-18-19-21-22 mm
	910/21		125 mm
	910/22		250 mm
	910/25		
	910/42		
	910/55	⊗	

335x145x60 mm



920A/C17M







009000924

~~€ 254,00~~

€ 147,00

12"

Assortimento di 17 chiavi a bussola esagonali e 5 accessori in termoformato morbido, in cassetta di lamiera

	920A	○	10-11-12-13-14-15-16-17-18-19 20-21-22-24-27-30-32 mm
	920/21		125 mm
	920/22		255 mm
	920/25		
	920/42		
	920/55	⊗	

420x185x60 mm



902A/C22









009020807

~~€ 283,00~~

€ 162,00

12"

Assortimento di 22 chiavi a bussola esagonali e 6 accessori in cassetta di lamiera

14"		900	○	5-5,5-6-7-8-9-10-11-12-13 mm
		900/20		50 mm
		900/25		
12"		920A	○	10-13-14-15-17-18-19-22-24 27-30-32 mm
		920/21		125 mm
		920/25		
		920/55	⊗	
		900/55	⊗	

420x185x60 mm



928A/C12







009280955

~~€ 623,00~~

€ 358,00

34"

Assortimento di 12 chiavi a bussola esagonali e 5 accessori in cassetta di lamiera

	928A	○	22-24-27-30-32-34-36-38-41 46-50-55 mm
	928/21		200 mm
	928/22		380 mm
	928/25		
	928/42		
	928/55	⊗	



530x220x80 mm

Chiavi dinamometriche a scatto con cricchetto reversibile

per serraggi destrorsi
precisione $\pm 4\%$

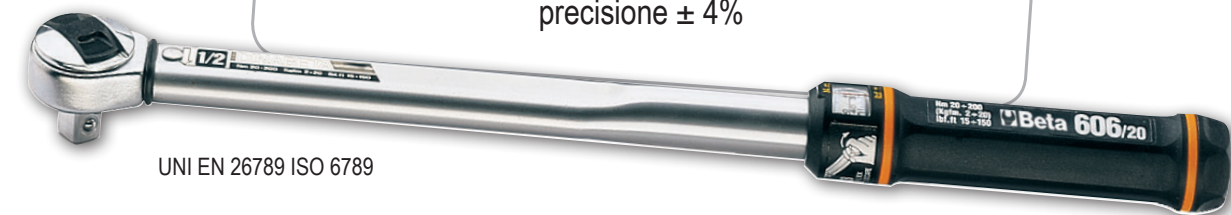

UNI EN 26789 ISO 6789

3/8"

8÷60 Nm
L= 305 mm

606/6

006060105

~~€ 170,00~~
€ 98,00

1/2"

20÷100 Nm
L= 345 mm

606/10X

006060111

~~€ 176,00~~
€ 102,00

1/2"

40÷200 Nm
L= 440 mm

606/20

006060120

~~€ 188,00~~
€ 109,00

1/2"

60÷330 Nm
L= 560 mm

606/30

006060130

~~€ 213,00~~
€ 123,00

Chiavi dinamometriche a scatto con cricchetto semplice

per serraggi destrorsi e sinistrorsi
precisione $\pm 4\%$



UNI EN 26789 ISO 6789

- Scala più grande del 60% per garantire una migliore visibilità e un settaggio più accurato
- Velocità di regolazione della coppia aumentata del 40%
- Materiale dell'impugnatura e della lente resistenti a tutte le sostanze chimiche utilizzate nell'automotive, nell'industria e nell'aviazione
- La banda colorata (o-ring rosso posto all'estremità dell'impugnatura) indica che la chiave è sbloccata ed è possibile regolare la coppia di serraggio
- In fase di non utilizzo impostare la coppia sul valore più basso del range della chiave dinamometrica
- Il Recalibration Reminder fornisce un'indicazione visiva del tempo mancante alla ricalibrazione della chiave (4 step: 3, 6, 9 e 12 mesi)

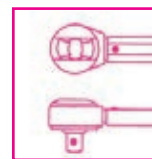

1/2"

40÷200 Nm
L= 470 mm

667N/20

006670020

~~€ 205,00~~
€ 118,00

1/2"

60÷300 Nm
L= 598 mm

667N/30

006670030

~~€ 230,00~~
€ 133,00

3/4"

80÷400 Nm
L= 711 mm

667N/40

006670040

~~€ 520,00~~
€ 298,00

Dinamometria

Chiave dinamometrica elettronica a lettura diretta per serraggi destrorsi ($\pm 2\%$) e sinistrorsi ($\pm 3\%$)



	Nm	Kgfm	lbf.ft	■	L mm	g	
599DGT/6	12÷60	1,2÷6	8÷44	3/8"	413	800	005990003
599DGT/10X	20÷100	2÷10	15÷80	1/2"	413	910	005990010
599DGT/20	40÷200	4÷20	30÷150	1/2"	520	1500	005990020
599DGT/30	68÷340	6,8÷34	58÷280	1/2"	539	2350	005990030

- Cricchetto reversibile:
- Display LCD
- Unità di misura: Nm, ft.lb, in.lb, kgcm:
- Doppia segnalazione, acustica e visiva
- Alimentazione: 2 batterie AA 1,5V incluse

3/8"

599DGT/6

~~€ 288,00~~
€ 165,00

1/2"

599DGT/10X

~~€ 298,00~~
€ 170,00

1/2"

599DGT/20

~~€ 320,00~~
€ 185,00

1/2"

599DGT/30

~~€ 350,00~~
€ 199,00

novità

601 C

006010100

~~€ 158,00~~
€ 92,00

Goniometro digitale per serraggi angolari, magnetico

- Per effettuare serraggi di viti a tensioni predefinite tramite la misurazione dell'angolo di torsione
- Dotato di avvisatore acustico (BUZZER) e avvisatori luminosi (LED) che segnalano l'avvicinamento e il raggiungimento dell'angolo impostato
- Per serraggi destrorsi e sinistrorsi
- Precisione angolo: $\pm 2\%$
- Risoluzione: $0,1^\circ$
- 9 valori di angolo preimpostabili
- 50 misurazioni preimpostabili
- Fornito in custodia ABS
- Alimentazione: 2 batterie AAA (incluse)



560/C6

005600160

~~€ 670,00~~
€ 388,00

6 kg

Moltiplicatore di coppia destrorso/sinistrorso in valigetta di materiale plastico

Rapporto 6,5:1

Fornito con leva di reazione diritta e piede di reazione



400x260x110 mm

Nm	Kgfm	lbf.ft	□	■
1500	150	1106	1/2"	3/4"



560/C12

005600210

~~€ 975,00~~
€ 565,00

7 kg

Moltiplicatore di coppia destrorso/sinistrorso in valigetta di materiale plastico

Rapporto 12:1

Fornito con leva di reazione diritta e piede di reazione

Nm	Kgfm	lbf.ft	□	■
2500	250	1844	1/2"	1"

1169BM/D3

011690123

~~€ 71,50~~
€ 41,00

Assortimento di 1 pinza universale,
1 pinza becchi mezzotondi lunghi
e 1 tronchese



1082BM 160 mm



1150BM 180 mm



1166BM 160 mm

1009L/DP-S2

010090060

~~€ 51,00~~
€ 29,50

Serie di 2 pinze
a becchi mezzotondi
lunghissimi zigrinati
con doppio snodo



45°

L 340 mm



1057A

010570124

~~€ 41,00~~
€ 23,50

Pinza automatica
autobloccante
con regolazione della forza

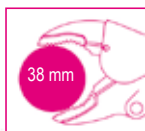

Pinze

Pinza regolabile a pulsante

- Regolazione rapida e precisa mediante la pressione del pulsante
- Nessuno spostamento accidentale della regolazione
- Trattamento termico localizzato sulle ganasce

L mm	∅ Max mm	 Max mm
180	30	27
240	36	32
300	50	48



1047/180

010470180

~~€ 33,00~~
€ 19,00

1047/240

010470240

~~€ 34,50~~
€ 20,00

1047/300

010470300

~~€ 51,00~~
€ 29,50

1048

010480015

~~€ 26,50~~
€ 15,00

Pinze regolabili cerniera chiusa

- Manici ricoperti con 2 strati di PVC antiscivolo

9 posizioni



L 250 mm

1031/54

010310000

~~€ 82,00~~
€ 47,00

Serie di 4 pinze per anelli elastici di sicurezza

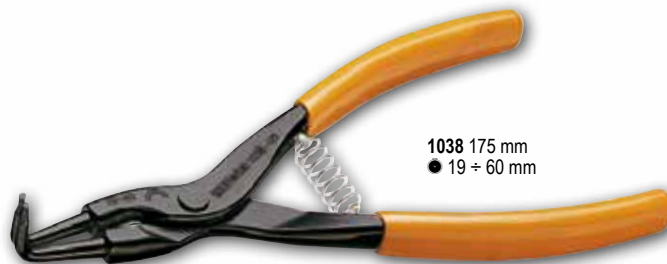

1038 175 mm
● 19 ÷ 60 mm



1034 170 mm
○ 19 ÷ 60 mm

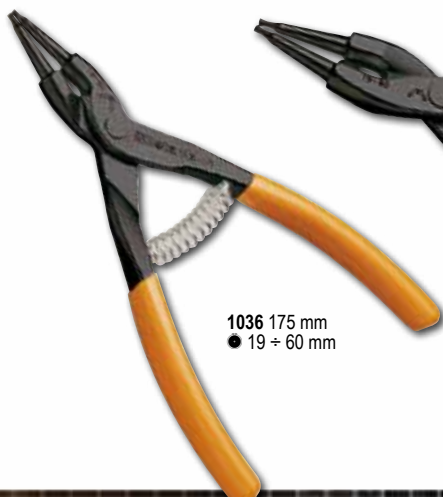

1036 175 mm
● 19 ÷ 60 mm



1032 180 mm
○ 19 ÷ 60 mm





1203/D8P

012030018

~~€ 30,50~~
€ 17,50

Serie di 8 giravite

1201 ● 2,5x50-3x75-4x100-5,5x100-6,5x150 mm
1202 ⊕ PH0x60-PH1x80-PH2x100 mm



1203/D10N

012030019

~~€ 38,50~~
€ 22,00

Serie di 10 giravite

1201 ● 2,5x50-3x75-4x100-5,5x150-6,5x150 mm
1202 ⊕ PH0x60-PH1x80-PH2x100 mm
1201N ● 4x30 mm
1202N ⊕ PH1x30 mm



1207TX/D7

012070207

~~€ 41,00~~
€ 23,50

Serie di 7 giravite

1207TX ⊙ T6-T8-T10-T15-T20-T25-T30



1263/D8

012630008

~~€ 42,50~~
€ 24,00

Serie di 8 giravite

1260 ● 2,5x50-3x75-4x100-5,5x125-6,5x150 mm
1262 ⊕ PH0x60-PH1x80-PH2x100 mm



1263/D10

012630010

~~€ 54,50~~
€ 31,00

Serie di 10 giravite

1260 ● 3x75-3,5x100-4x125-5,5x150-6,5x150 mm
1262 ⊕ PH0x60- PH1x80-PH2x100 mm
1260N ● 4x30 mm
1262N ⊕ PH1x30 mm



1267TX/D7

012670307

~~€ 56,00~~
€ 32,00

Serie di 7 giravite

1267TX ⊙ T6-T8-T10-T15-T20-T25-T30

1293/D8

012930403

~~€ 59,00~~
€ 34,00

Serie di 8 giravite

1201 ● 3x75-4x100-5,5x100-6,5x150-8x150 mm
1202 ⊕ PH0x60-PH1x80-PH2x100 mm



1243/D7

012430017

~~€ 72,00~~
€ 42,00

Serie di 7 giravite a battere

1241 ● 5,5x100-6,5x125-8x150-10x200 mm
1242 ⊕ PH1x100-PH2x100-PH3x150 mm



Martelli e scalpelli

31BM/D6

000310420

~~€ 78,50~~
€ 46,00

Serie di 6 cacciaspina con impugnatura

Ø 2-3-4-5-6-8 mm



38/B6

000380006

~~€ 48,50~~
€ 28,50

Serie di 2 punzoni, 1 bulino, 2 scalpelli piatti e 1 ugnetto in busta

30: Ø 2-3 mm

32: Ø 4 mm

34: 125-150 mm

36: 150 mm



1370

Martello tipo tedesco per meccanici
manico in legno

	g		€	€
1370/200	200	013700052	€ 9,80	€ 5,50
1370/300	300	013700053	€ 11,30	€ 6,50
1370/500	500	013700055	€ 13,80	€ 8,00
1370/800	800	013700058	€ 18,00	€ 10,50
1370/1000	1000	013700060	€ 21,00	€ 12,00
1370/1500	1500	013700065	€ 24,50	€ 14,00



1390

Mazzuole con battenti intercambiabili in materiale plastico
manico in legno

	Ø mm		€	€
1390/22	22	013900022	€ 13,40	€ 7,70
1390/28	28	013900028	€ 17,00	€ 9,80
1390/35	35	013900035	€ 22,70	€ 13,00
1390/45	45	013900045	€ 37,00	€ 21,50
1390/60	60	013900060	€ 63,00	€ 36,50



1392

Mazzuole antirimbalo con battenti intercambiabili in materiale plastico
manico in acciaio

	Ø mm		€	€
1392/30	30	013920030	€ 36,00	€ 21,00
1392/35	35	013920035	€ 38,00	€ 22,00
1392/40	40	013920040	€ 43,00	€ 25,00
1392/50	50	013920050	€ 52,00	€ 30,00
1392/60	60	013920060	€ 79,00	€ 46,00

Brevettato

novità

1128BAX

011280088

~~€ 24,00~~

€ 13,80

Forbici per elettricisti a doppio effetto, con profili a fresa in acciaio inossidabile rivestito in DLC



**+ durezza
- coefficiente
d'attrito**

Rivestimento DLC:

Il DLC (diamond-like carbon) è un rivestimento innovativo a base di carbonio: l'elevata durezza ed il basso coefficiente d'attrito nascono dalla simultanea presenza di carbonio depositato sulla superficie in forma di Grafite e Diamante.



Taglio a doppio effetto: - sforzo + potenza

una speciale camma sul fulcro riduce del 20% lo sforzo di taglio

- Alta durezza superficiale delle lame (resistenza all'abrasione e mantenimento dell'affilatura nel tempo)
- Basso coefficiente di attrito (scorrevolezza e potenza di taglio)
- Fornite con custodia plastica snodata



- Manici ampi con gole strozzatubi

Profilo a fresa: studiato per allargare fori su particolari in plastica da 13 a 24 mm.



novità

1130BMX

011300001

~~€ 21,00~~

€ 12,00

Forbici multiuso lame dritte in acciaio inossidabile con microdentatura



Meccanismo a molla

1719BMA8/S5

017190070

~~€ 61,50~~

€ 35,50

Serie di lime a taglio mezzodolce impugnatura in materiale plastico



T ▲ Q ■ P I R ● M D

200 mm

novità

1778SCL

017780089

~~€ 23,00~~
€ 13,50

Coltello a serramanico
con finitura soft carbon look
lama in acciaio temprato
• in astuccio



1778SOS

017780080

~~€ 24,50~~
€ 14,50

Coltello soccorso auto
con funzione martello frangicristallo
e tagliacinture di sicurezza
• in astuccio



Impugnatura
in alluminio anodizzato

1777T

017770030

~~€ 19,00~~
€ 11,00

Cutter a serramanico
con lama trapezoidale
impugnatura in alluminio
fornito con 5 lame



Impugnatura
in alluminio anodizzato

1771

017710000

~~€ 7,00~~
€ 4,00

Cutter 18 mm con blocco automatico
della lama, con struttura interna
in acciaio inossidabile
fornito con 3 lame



1770BM

017700050

~~€ 9,50~~
€ 5,50

Cutter 9 mm con blocco automatico
della lama, con struttura interna
in acciaio inossidabile.
fornito con 6 lame



412/SPI9P

004120429

~~€ 48,00~~
€ 28,00

Serie di 19 punte elicoidali cilindriche, in acciaio HSS, rettificata lucide

Ø 1÷10 x 0,5 mm
115x170x40 mm



415CO/SPI9A

004150440

~~€ 101,00~~
€ 58,00

Serie di 19 punte elicoidali cilindriche, in acciaio HSS-CO 5%

• Per forare acciaio INOX, acciai legati, ghisa, acciai dolci, leghe leggere

Ø 1÷10 x 0,5 mm
115x170x40 mm



novità

429/C7

004290207

~~€ 208,00~~
€ 175,00

Serie di 7 maschi a macchina per fori passanti passo grosso, in acciaio HSS-CO

M 3x0,5 - 4x0,7 - 5x0,8 - 6x1 - 8x1,25 - 10x1,5 - 12x1,75

R≤1000N/m²
HV 820÷850

• con anello bianco
• maggiore durezza superficiale, resistenza a usura e ridotta tendenza all'incollamento dei trucioli



425P/SP3

004250610

~~€ 180,00~~
€ 105,00

Serie di 3 frese coniche a gradino, con taglienti elicoidali in acciaio HSS-G con affilatura più efficace

Ø 4÷12; 4÷20; 4÷30 mm
100x145x40 mm

novità



446/C110

004460060

~~€ 645,00~~
€ 370,00

Assortimento di 105 maschi e filiere con 5 accessori in acciaio al cromo, filettatura metrica in cassetta di legno

430 M mm	433 M mm	440/440A M mm	441/441A M mm
2x0,4	6x0,75 - 7x0,75	2x0,4	6x0,75 - 7x0,75
3x0,5	8x0,75 - 8x1	3x0,5	8x0,75 - 8x1
4x0,7	9x0,75 - 9x1	4x0,7	9x0,75 - 9x1
5x0,8	10x0,75 - 10x1	5x0,8	10x0,75 - 10x1
6x1	10x1,25 - 11x0,75	6x1	10x1,25 - 11x0,75
7x1	11x1 - 11x1,25	7x1	11x1 - 11x1,25
8x1,25	12x0,75 - 12x1	8x1,25	12x0,75 - 12x1
9x1,25	12x1,25 - 12x1,5	9x1,25	12x1,25 - 12x1,5
10x1,5	14x1 - 14x1,25	10x1,5	14x1 - 14x1,25
11x1,5	14x1,5 - 16x1	11x1,5	14x1,5 - 16x1
12x1,75	16x1,5 - 18x1,5	12x1,75	16x1,5 - 18x1,5
14x2		14x2	
16x2		16x2	

435/0 444/1 436/1
435/3 444/2



500x337x60 mm

Max 150 mm

1651DGT

016510111

~~€ 98,00~~
€ 57,00

A Max mm	L mm
150	225

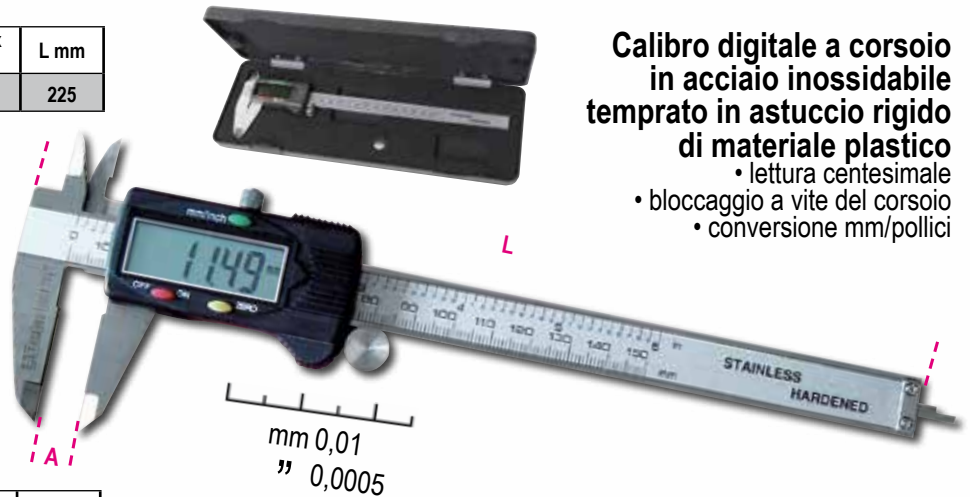

Calibro digitale a corsoio in acciaio inossidabile temprato in astuccio rigido di materiale plastico

- lettura centesimale
- bloccaggio a vite del corsoio
- conversione mm/pollici

Max 200 mm

1651LDGT

016510112

~~€ 110,00~~
€ 64,00

A Max mm	L mm
200	285

mm 0,01
" 0,0005

DIN 862 UNI EN ISO 13385-1



1692

Flessometri cassa bimateriale in ABS antiurto, nastro in acciaio classe di precisione II

	L m	S mm		€	€
1692/2	2	16	016920052	€ 5,70	€ 3,30
1692/3	3	16	016920053	€ 7,20	€ 4,20
1692/5	5	18	016920055	€ 10,40	€ 5,90
1692/8	8	25	016920058	€ 15,00	€ 8,70



1695XS

016950250

~~€ 9,50~~
€ 5,50

Livella tascabile con base a "V" magnetica in alluminio profilato 2 file infrangibili precisione 1mm/m

- Fornita con clip
- Magnetica tascabile



Ideale per tubi e sezioni tonde in genere



Livelle con base magnetica in alluminio profilato anodizzato a 2 file infrangibili

novità

L 200 mm H 49 mm S 22 mm

1696B200

016960202

~~€ 24,00~~
€ 14,00

L 300 mm H 49 mm S 22 mm

1696B300

016960203

~~€ 26,00~~
€ 15,00

L 400 mm H 49 mm S 22 mm

1696B400

016960204

~~€ 27,50~~
€ 16,00



1500

Estrattori universali a 2 griffe

- impiego sia per esterni che per interni.
- griffe mobili lungo la traversa con dadi di bloccaggio.

	Carico Kg	A min ÷ Max	mm		€	€
1500/1	4500	25÷ 80 mm	17	015000301	€ 62,00	€ 36,00
1500/2	4500	25÷ 130 mm	17	015000302	€ 65,00	€ 38,00
1500/3	6000	50÷ 160 mm	22	015000303	€ 105,00	€ 61,00
1500/4	6000	60÷ 200 mm	22	015000304	€ 148,00	€ 86,00

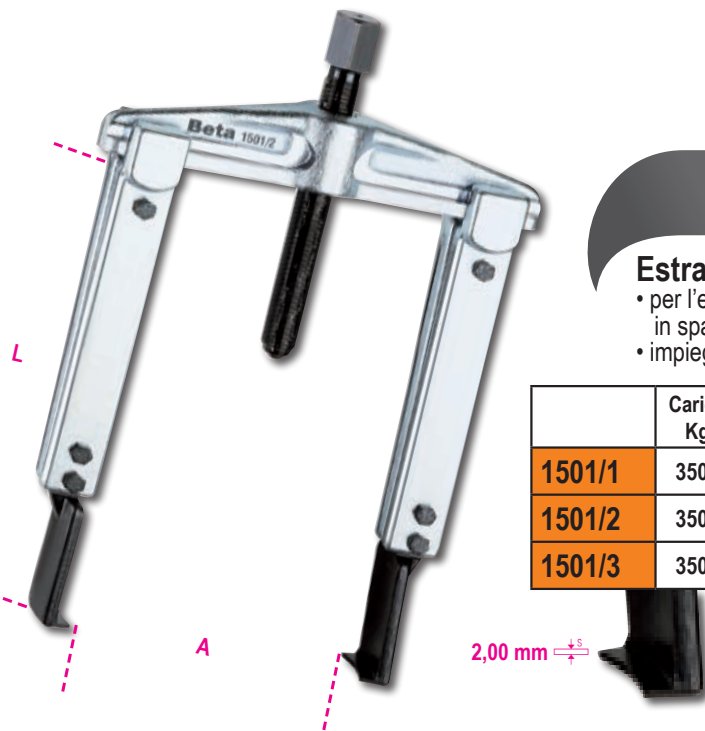
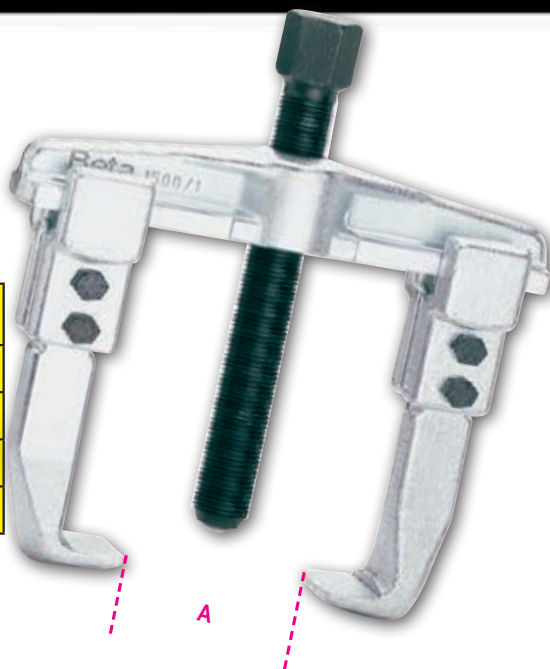

1501

Estrattori a griffe sottili

- per l'estrazione d'ingranaggi e organi alloggiati in spazi ristretti.
- impiego sia per interni che per esterni.

	Carico Kg	A min ÷ Max	L mm	mm		€	€
1501/1	3500	25÷ 130 mm	100	17	015010101	€ 145,00	€ 84,00
1501/2	3500	25÷ 130 mm	200	17	015010102	€ 155,00	€ 90,00
1501/3	3500	25÷ 130 mm	250	17	015010103	€ 160,00	€ 93,00



1517

Estrattori a 3 griffe autoserranti

- per elevati carichi d'estrazione.
- effetto autoserrante.
- apertura contemporanea delle griffe.
- effetto autoserrante.
- doppio dado di manovra.
- le misure 90 e 150 sono dotate di una coppia di piattelli per estrazioni su alberi cavi.



	Carico Kg	A min ÷ Max	mm	mm		€	€
1517/90	6000	18÷90 mm	22	19	015170000	€ 185,00	€ 108,00
1517/150	6000	25÷150 mm	22	19	015170010	€ 198,00	€ 115,00
1517/200	6000	40÷200 mm	22	19	015170020	€ 227,00	€ 131,00
1517/260	8000	50÷ 260 mm	30	27	015170030	€ 255,00	€ 148,00

Estrattori

1428/SBII

014280111

~~€ 164,50~~
€ 95,00

Serie di 11 estrattori a bussola
per dadi danneggiati
con supporto



3/8" 8-10-11-12-13-14 mm 1/2" 15-16-17-18-19 mm

1545/C5M

015450011

~~€ 394,00~~
€ 228,00

Estrattore 1542/1
con 5 Espansori 1544
in cassetta di lamiera

	A mm	C mm
1544/1	9÷12	0,80
1544/2	13÷17	1,15
1544/3	16÷21	1,70
1544/4	20÷25	1,65
1544/5	25÷30	2,00



420x185x60 mm

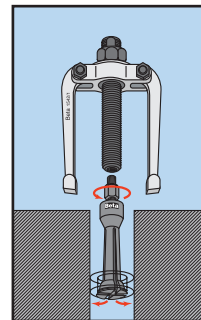

1547/C6

015470006

~~€ 205,50~~
€ 119,00

Estrattori per cuscinetti
con false sfere
in cassetta di lamiera

• utilizzabile solo dopo aver
"sgabbiato" le sfere.

Cuscinetti:

1547/1

6011-6014, 6206-6211, 6303-6308, 6403-6405 1

1547/2

6004-6010, 6200-6205, 6300-6304



420x185x60 mm



334

003340001

~~€ 22,50~~
€ 13,00

Tagliatubi per rame
e leghe leggere



Con lama svasatubi

Ø 3÷30 mm
1/8"÷1"1/8

342

003420030

~~€ 37,00~~
€ 21,50

Cesoia a cricchetto
per tubi in materiale plastico



Ø 0÷42 mm
1"5/8

351C

003510010

~~€ 110,00~~
€ 64,00

Tagliatubi ed attrezzo bordatubi
in cassetta di materiale plastico



334 Ø 3÷30 mm
1/8"÷1"1/8



350 Ø 4÷14 mm



351P Ø 4-4,75-6-8-10-12-14 mm

- L'assortimento di sette puntali permette, di realizzare una bordatura doppia a 45°

225x150x45 mm

388C/C8

003880200

~~€ 345,00~~
€ 199,00

Attrezzo curvatubi
con 7 matrici
in alluminio per rame
ricotto e lega leggera
in cassetta di plastica



Ø mm 10,12,14,16,18,20,22



400x330x110 mm

Giratubi modello svedese
con ganasce sottili a 45°
in acciaio forgiato

L= 320 mm
Ø max 1" gas
Ø max 34 mm

378/320

003780032

~~€ 39,50~~
€ 23,00

L= 410 mm
Ø max 1" 1/2 gas
Ø max 49 mm

378/410

003780041

~~€ 51,50~~
€ 29,50

L= 550 mm
Ø max 2" gas
Ø max 60 mm

378/550

003780055

~~€ 82,50~~
€ 48,00



Giratubi modello Stillson
in acciaio forgiato

L= 350 mm
Ø max 1" 1/2 gas
Ø max 49 mm

360/350

003600035

~~€ 35,00~~
€ 20,00

L= 450 mm
Ø max 2" gas
Ø max 60 mm

360/450

003600045

~~€ 49,50~~
€ 28,50

L= 600 mm
Ø max 2" 1/2 gas
Ø max 76 mm

360/600

003600060

~~€ 76,00~~
€ 44,00



1149F

011490010

~~€ 12,50~~

€ 7,20

Pinza spellafili frontale autoregolabile, con dispositivo di taglio

- Adattamento automatico ai diametri dei conduttori
- Lunghezza della spellatura regolabile
- Regolazione della pressione di taglio isolante
- Dispositivo di taglio integrato

Spellature rapide e precise



0,2÷6 mm²
28÷17 AWG

1609B

016090101

~~€ 230,00~~

€ 133,00

Pinza crimpatrice meccanica

- Per capicorda in rame non isolati da 10 a 120 mm²
- Impugnatura in gomma antiscivolo
- Perno interno con sezione ad "H" per la massima scorrevolezza del punzone
- In acciaio brunito



L 600 mm

10÷120 mm²

1606A/C9

016060100

~~€ 128,00~~

€ 75,00

Pinza per capicorda a tubetto con assortimento di 450 capicorda da 0,5 mm² a 6 mm²



420x350x35 mm









1256/C36-2

012560100

~~€ 50,00~~

€ 29,00

Microgiravite bimateriale con 36 inserti intercambiabili da 4 mm e prolunga magnetica

	1256TX	⊕	T3-T4-T5-T6-T7-T8-T9-T10-T15
	1256RTX	⊗	T6-T7-T8-T9-T10
	1256LP	●	0,8-1,2-1,5-1,8-2-2,5-3-3,5-4 mm
	1256PE	○	0,7-0,9-1,3-1,5-2 mm
	1256PH	⊕	PH000-PH00-PH0-PH1
	1256PZ	⊕	PZ000-PZ00-PZ0-PZ1
	1256/20		
	1256/30		

per lavori di precisione



130x60x35 mm

1257LPH/S8

012570210

~~€ 47,50~~
€ 27,50



**Serie di 8 microgiravite
Lama Piatta e Phillips®
in astuccio plastico rigido**

- 1257LP: 0.4x2; 0.4x2.5; 0.5x3; 0.6x3.5; 0.8x4mm
- 1257PH: PH00; PH0; PH1



180x117x44 mm

1760/OHM

017600025

~~€ 590,00~~
€ 348,00



**Adatto per veicoli
ibridi ed elettrici**



**Multimetro/megaohmetro
per test isolamento ad alta tensione.
Lettura a valore efficace TRUE RMS**

Tensione AC/DC:	50mV - 1000V	Precisione base	±0.06% - ±0.1% rdg
Corrente AC/DC:	0.01µA - 10A		±0.5% - ±1% rdg
Resistenza:	0.01Ω - 50MΩ		±0.2% - ±2% rdg
Meg OHM:	0.01 - 5000MΩ		±4% rdg. max current 1mA
Capacità:	5nF - 10mF		±1.5% - ±3% rdg
Frequenza:	50Hz - 100 MHz		±0.02% - ±0.1% rdg
Temperatura	-50°C - +1350°C		±0.5% rdg
Test diodi:	3V dc		
Test continuità:	<30 Ω		



- Protezione dall'acqua IP67
- Ingressi protetti • Autoranging
- Ampio display di immediata lettura, retroilluminato blu
- Sonda temperatura tipo K (inclusa) • Autospegnimento
- Base in gomma portaterminale
- per un maggiore comfort durante l'uso
- Terminali a doppio isolamento 1000V, lunghezza 1 m
- In custodia morbida • CAT IV 600V/ CAT III 1000V
- Vero valore efficace TRUE RMS



1760/RMS

017600020

~~€ 215,00~~
€ 125,00



**Multimetro digitale industriale
preciso e robusto in un guscio
costampato di 6 mm,
con gomma esterna antiscivolo
ed antiurto**

Tensione AC/DC	110mV - 600V ±0.8%	Precisione base	- ±2% rdg
Corrente AC/DC	110µA - 10A ±1.5%		- ±2% rdg
Resistenza	110Ω - 40MΩ ±1.2%		- ±2.5% rdg
Capacità	11nF - 40mF ±5%		- ±10% rdg (fino a 11mF)
Frequenza	1100Hz - 110 MHz ±1.2%		- ±1.5% rdg
Temperatura	-32°C - +1000°C ±3%		- ±5% rdg
Test diodi	3V dc ±10% rdg		
Test continuità	<30 Ω		



**A prova di
caduta da 2 m**

novità

2115P L-MQ32

021150332

~~€ 887,00~~
€ 495,00

Assortimento di 32 utensili isolati per auto ibride, in cestello plastico con termoformato morbido EN 60900

Adatto per veicoli ibridi ed elettrici

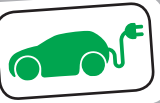

	89MQ	10-12 mm
	850MQ	1/4"
	860TX/A10	T7-T8-T9-T10-T15-T20 T25-T27-T30-T40
	920MQ/55A	1/2"
	920MQ/A	8-10-12-13-14-17-19 mm
	920MQ/21	1/2" 125 mm
	920MQ/22	1/2" 250 mm
	1048MQ250	250 mm
	1150MQ	180 mm
	1164MQ160	160 mm
	1272MQ	4.5X80-6X100 mm
	1274MQ	3X100-4X100-5.5X125
	1995MQ/G2	
	CP15L	

558x277x270 mm



1169MQ/D2

011690143

~~€ 73,50~~
€ 42,00

Assortimento di 1 pinza universale isolata e 1 tronchese isolato



1150MQ 180 mm

1082MQ 160 mm



1273MQ/D6

012730851

~~€ 51,00~~
€ 29,50

Serie di 6 giravite isolati



1274MQ
3x100-4x100-5,5x125 mm

1272MQ
PH0x60-PH1x80-PH2x100 mm



Beta INOX

STAINLESS STEEL

novità

CO4TSS/7

024003077

~~€ 1.890,00~~

€ 1.100,00

Cassettera mobile con 7 cassetti completamente in acciaio inossidabile

- Sette cassetti da 570 x 410 mm montati su guide telescopiche a sfera; 6 cassetti altezza 83 mm; 1 cassetto altezza 170 mm
- 4 ruote Ø 125mm 2 fisse e 2 girevoli (due con freno)
- Serratura frontale centralizzata
- **Struttura interamente in acciaio inossidabile**
- **Ruote, supporti, sfere, interno dei cassetti e relative guide in acciaio inossidabile**
- Maniglia cassetti in alluminio

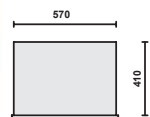

h	max.
83 mm	25 kg
170 mm	30 kg

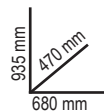
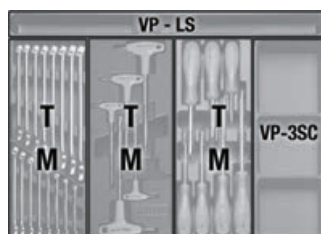

Gli utensili Beta Inox possono essere sterilizzati in autoclave a 121°C

42INOX/SC9

000420387

~~€ 136,50~~

€ 79,00

Serie di 9 chiavi combinate in acciaio inossidabile con supporto compatto



8-10-11-12-13-14-15-17-19 mm

1293INOX/D8

012930408

~~€ 62,00~~

€ 36,00

Serie di 8 giravite in acciaio inossidabile

1290INOX ● 2,5x50-3x75-4x100
5,5x150-6,5x150 mm



1292INOX ⊕ PH0x60-PH1x80
PH2x100 mm



1740B280

017400280

~~€ 53,00~~
€ 30,50

2,4÷4,8 mm acciaio

1740B330

017400330

~~€ 63,00~~
€ 36,50

3,2÷6,4 mm acciaio

174IU

017410450

~~€ 34,00~~
€ 19,50

Rivettatrice ultra compatta
con regolazione dello sforzo



2,4÷4,0 mm acciaio

Rivettatrici di potenza compatte

- Rapporto di leva ottimizzato per una maggiore compattezza e praticità d'uso.
- 3 griffe per una presa perfetta del rivetto.
- Testa regolabile per tirare il rivetto da 2 a 5 movimenti dei bracci.



3 griffe:
migliore presa
del rivetto

Serbatoio
portasteli



3 griffe:
migliore presa
del rivetto

Solo 200 mm

1749AC

017490005

~~€ 28,00~~
€ 16,00

Pistola ad alta spinta
per ancoranti chimici e
cartucce standard



1750 500

017500500

~~€ 31,00~~
€ 18,00

Compressore a leva
per grasso, 500 cc



550 Bar

1756D

017560515

~~€ 57,00~~
€ 33,00

Siringa per olio da 1500 ml in polipropilene

- doppia guarnizione in NBR
- temperatura di funzionamento: +0 - +50°C
- NON adatta per carburanti

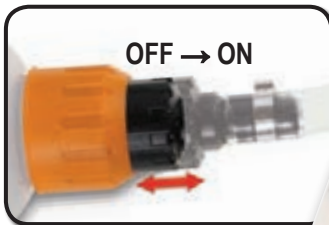

1500 ml



1873

018730030

~~€ 470,00~~
€ 270,00

Aspiratore 30 litri per solidi e liquidi, in acciaio INOX

CARATTERISTICHE TECNICHE

- motore by-pass bistadio
- tensione 230/240 V
- frequenza 50/60 Hz
- potenza Max 1100 W
- portata d'aria l/sec. 55
- depressione Max 220 mbar
- capienza Max bidone in acciaio Inox: 30 l
- emissioni acustiche <61 dB(A)
- lunghezza cavo 6 m
- carrello porta accessori

ACCESSORI IN DOTAZIONE Ø 45mm

- 1 tubo corrugato completo di impugnatura ergonomica
- 2 tubi in plastica di prolunga
- 1 telaio spazzola industriale
- 1 inserto industriale moquette
- 1 inserto industriale con gomme raccogli liquidi
- 1 bocchetta a lancia
- 1 bocchetta triangolare

SISTEMI FILTRANTI

- 1 sacco in carta filtro
- 1 cartuccia filtro superficiale 1900 cm² 12 micron nom.
- 1 filtro anti-schiuma PPI 45/PPI 30

IPX4



- Funzione soffiante
- Ruote antitraccia



1870

018700020

~~€ 165,00~~
€ 95,00

Aspiratore 20 litri per solidi e liquidi

ACCESSORI IN DOTAZIONE Ø 36 mm

- 1 tubo corrugato completo di impugnatura ergonomica
- 2 tubi rigidi di prolunga
- 1 spazzola multiuso per pavimenti e liquidi
- 1 bocchetta a lancia

SISTEMI FILTRANTI

- 1 cartuccia filtro aria superficiale 1900 cm² - 12 micron nom.
- 1 filtro anti-schiuma PPI 45/PPI 30

IPX4



- Ruote antitraccia

CARATTERISTICHE TECNICHE

- motore by-pass monostadio
- tensione 230/240 V
- frequenza 50/60 Hz
- potenza Max 1200 W
- portata d'aria l/sec. 58
- depressione Max 190 mbar
- capienza Max bidone 20 l in PP antistatico
- emissioni acustiche <70 dB(A)
- lunghezza cavo 5 m
- carrello porta accessori



7042LCD

070420001

~~€ 138,00~~
€ 80,00

Maschera LCD
ad oscuramento automatico,
per saldatura ad elettrodo,
MIG/MAG, TIG e plasma.
Alimentazione a celle solari
e batterie al litio per una durata
eccezionale del filtro LCD

- Area di visuale 98x43 mm
- Tonalità di oscuramento DIN 9-13 con regolazione esterna
- Protezione UV/IR
- Tempo d'oscuramento 1/25000 s (ansi Z87.1)
- Tempo di rischiaramento 0.25-1s
- Sensibilità e ritardo dell'oscuramento regolabili
- Accensione e spegnimento automatici
- Funzione di smerigliatura
- Forma ottimizzata per agevolare la respirazione a schermo abbassato



Saldatrice inverter

ad elettrodo in corrente continua (DC).compatta e facile da trasportare fornita di cavi, martospazzola e tracolla.
Funzioni: arc force, hotstart, anti-sticking, protezione termostatica

1860K/160A

018600160

~~€ 780,00~~
€ 440,00

200 mm
330 mm
130 mm



1860E/120A

018600120

~~€ 450,00~~
€ 255,00

200 mm
270 mm
120 mm



1860E/150A

018600150

~~€ 570,00~~
€ 325,00

200 mm
330 mm
130 mm



	1860E/120A	1860E/150A	1860K/160A
Corrente di regolazione	5÷120A	5÷150A	5÷155A
Alimentazione	1x230V	1x230V	1x230V
Potenza assorbita	MAX 2.5 KVA	MAX3,3 KVA	MAX 3,7 KVA
Fattore di utilizzo (40°C) :	35% - 120 A 60% - 70 A 100% - 55 A	35% - 150 A 60% - 120 A 100% - 100 A	35% - 150 A 60% - 130 A 100% - 100 A
Fusibile ritardato	12 A	16 A	20 A
Protezione	IP21	IP23	IP21
Uso con generatori	X	X	✓
Temperatura di esercizio	-15/+40° C (+5/+104° F)	-15/+40° C (+5/+104° F)	-15/+40° C (+5/+104° F)
Elettrodi utilizzabili	Ø 1.5 - 3.25 mm utilici, basici, in ox, ghisa, ecc.	Ø 1.5 - 4 mm utilici, basici, inox, ghisa, ecc.	Ø 1.5 - 4 mm utilici, basici, inox, ghisa, ecc.

novità

1837N

018370002

~~€ 59,00~~
€ 34,00

Lampada magnetica snodata con LED ad alta luminosità fino a 400 Lumen

- Batterie (non incluse) :
 - 1xAA (durata 25/69 h)
 - 2xAA (durata 33/96 h)
 - 3xAA (durata 43/124 h)
 • Lumen: 400>40>OFF
 • Indicatore di carica
 • Cono luminoso regolabile
 • IPX6

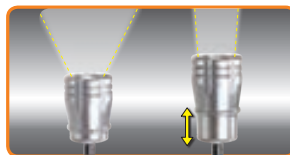
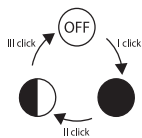

novità

Torcia LED ad alta luminosità in robusto alluminio anodizzato

1834P XL

018340330

~~€ 69,00~~
€ 40,00



1834P L

018340325

~~€ 55,00~~
€ 32,00



1834P M

018340320

~~€ 34,00~~
€ 19,50



1834P S

018340310

~~€ 27,50~~
€ 16,00



finitura opaca



1836

018360100

~~€ 37,50~~
€ 22,00

Lampada da testa LED snodata, con doppia luminosità e sensore on/off



Fuoco regolabile
 90 Lumen



1838 FLASH

018380300

€ 235,00

€ 135,00



Faretto ricaricabile ultracompatto, studiato per offrire la migliore soluzione possibile in ogni utilizzo.

- LED ad altissima luminosità
- IP 65
- Robusto ed affidabile
- Batteria ai polimeri di litio 7,4 V 4000 mAh

Brevettato



illuminazione abbondante e sempre pronta

Compatto 80x95x155 mm

Posizionabile ovunque: su piani, con cavalletto 1/4", con magnete svitabile



novità *kit per la ricerca di perdite da impianti*

Composto da:

- Lampada ricaricabile UV e luce bianca, con caricatore
- Occhiali ad alto contrasto antiUV, con custodia

1838UV/S2

018380850

€ 127,00

€ 74,00



COB LED



UV-395nm



150 lumen/UV LED



3h/3h



3,7V/1600mAh Li-on



3h



Charger input: 100-240Vac 50/60Hz



IP 20



-10° to +40°C

novità

1838/1LED

018380111

~~€ 118,00~~
€ 68,00

Lampada ricaricabile con LED ad altissima luminosità batteria ai polimeri di litio

- Corpo compatto in gomma antiscivolo
- Con stazione di ricarica 110-230Vac



<20%

testa ancora più compatta



LED in testa per illuminazione multi direzionale

Gancio orientabile



Vetrino frontale facilmente sostituibile

320 Lumen

1842LED/BM

018420301

~~€ 95,00~~
€ 55,00

lampada con LED ad altissima luminosità, 100-240Vac

- Corpo compatto in gomma antiscivolo
- Vetrino frontale facilmente sostituibile
- Gancio orientabile
- Con LED in testa per illuminazione multidirezionale

novità

1842LED/ABM

018420311

~~€ 95,00~~
€ 55,00

Lampada con LED ad altissima luminosità, 12-24 V; AC-DC

- Corpo compatto in gomma antiscivolo
- Vetrino frontale facilmente sostituibile
- Gancio orientabile
- Con LED in testa per illuminazione multidirezionale

320 Lumen

Cavo da 10 m

1846LED/BM

018460301

~~€ 295,00~~
€ 170,00

Avvolgitore automatico completo di lampada a LED, 100-240 Vac

- Con trasformatore di sicurezza 230/24V Max. 25 W

1846LED/ABM

018460311

~~€ 285,00~~
€ 165,00

Avvolgitore automatico completo di lampada a LED alimentazione 12-24 V; AC-DC Max. 60 W

novità



1760PA/80

017600002

~~€ 160,00~~
€ 92,00



Pinza amperometrica AC/DC 80A

Specifica per misurazioni di bassi valori di dispersione della corrente o assorbimenti sui veicoli

Ideale per le basse dispersioni 1mA-80A



- range: 1mA-80A AC/DC
- funzione torcia con led bianco
- display LCD retroilluminato
- funzione azzeramento
- funzione Hold
- autospegnimento
- alimentazione: 2 batterie 1,5V tipo AAA
- luce LED



1760PA/AC-DC

017600000

~~€ 220,00~~
€ 128,00



Pinza amperometrica e multimetro digitale

- permette le misurazioni di CC e CA fino a 1000 A
- funzione multimetro integrata
- A: AC/DC
- V: AC/DC



- PARAMETRI RILEVABILI**
- Tensione DC: 0.1mV ÷ 600V
 - Tensione AC: 0.1mV ÷ 600V
 - Corrente DC: 0.01A ÷ 1000A
 - Corrente AC: 0.01A ÷ 1000A
 - Resistenza: 0.1Ω ÷ 40MΩ
 - Capacità: 0.001nF ÷ 40 μF
 - Frequenza: 0.001kHz ÷ 4kHz
 - Temperatura: -40°C ÷ 1000 °C
 - 40°F ÷ 1832°F
 - Alimentazione: 1 batteria da 9V (inclusa)

1497/C94

014970300

~~€ 295,00~~
€ 170,00

Assortimento di 94 connettori per test su autovetture

Utilizzabili con i principali strumenti di diagnosi

INCLUSI NELL'ASSORTIMENTO:

- 2 rubacorrente
- 2 potenziometri
- 2 spie di segnalazione
- 2 connettori SRS
- 2 coccodrilli
- 2 sonde ad ago
- 2 puntali
- 2 connettori doppi a banana
- 4 connettori a banana singoli
- 24 terminali maschio piatti 0.6÷6 mm
- 12 terminali maschio tondi 1.6÷3.9 mm
- 24 terminali femmina piatti 0.6÷6 mm
- 12 terminali femmina tondi 1.6÷3.9 mm

430x390x100 mm



novità

1497RC

014970351

~~€ 55,00~~
€ 32,00

Coppia di rubacorrente

- prelevano il segnale senza danneggiare i cavi
- sezione cavi: 1,5÷3,5 mm
- voltaggio: 0÷330V
- corrente massima 5A



novità

961D

009610500

~~€ 1.305,00~~

€ 718,00



Videoscopio digitale elettronico con sonda da 5,5 mm

Permette di visualizzare, fotografare e registrare singole immagini e filmati direttamente sullo strumento

- sonda con testa Ø 5,5 mm e lunghezza 90 cm
- display LCD TFT da 7" (18 cm) con risoluzione da 800x480
- camera digitale con visione frontale e laterale
- zoom digitale 2X

Sonda Ø 5,5 mm con camera frontale e laterale a 4 led



DATI TECNICI:	
Distanza ottimale di visualizzazione	2,5-30 cm
Alimentazione	3,7V - 4200 mAh
Autonomia stimata	2,5-4 ore
Peso	520g
Risoluzione sensore	640x480 pixels (digitale)
Ampiezza di visualizzazione	60 gradi
Risoluzione di video e foto	640x480
Dimensioni	184x144x27 mm



Ingresso micro-SD Card



Microfono



Micro USB



Micro HDMI



novità

961D/CF3,8

009610511

~~€ 548,00~~

€ 312,00



Sonda da 1 metro con camera frontale da 3,8 mm

novità

961D/DC8,5

009610513

~~€ 478,00~~

€ 272,00



Sonda da 1 metro con doppia camera UV

961P6

009610000

~~€ 538,00~~

€ 310,00



961P4

009610004

~~€ 538,00~~

€ 310,00

Videoscopio elettronico con sonda flessibile

Permette di registrare video o singole immagini direttamente sullo strumento

- supporta l'utilizzo di SD CARD e memorie flash (8 GB)
- 4 led di illuminazione
- alimentazione tramite presa USB (batteria incorporata)
- uscita dati: cavo USB e SD card



	961P6	961P4
Specchietto 45° e magnete	✓	✗
Memoria interna	32MB	32MB
Uscita TV-OUT	✓	✓
Pixel del sensore	640x480	640x480
Risoluzione massima	320x240	320x240
Lunghezza sonda	1 m	1 m
Diametro camera	6 mm	4,5 mm
Formati video	MPEG4, 3GP, AVI, ASF.	MPEG4, 3GP, AVI, ASF.
Formati foto	JPEG	JPEG
Angolo di ripresa	0÷180°	0÷180°
Alimentazione	3,7V 2000 mAh	3,7V 2000 mAh

	961P4	961P6	L (m)	Ø mm		€
961P6/S2	✓	✓	2	6	009610262	€ 265,00 € 155,00
961P6/S3	✓	✓	3	6	009610263	€ 310,00 € 177,00

novità

1464T

014640050

~~€ 660,00~~

€ 378,00

CARATTERISTICHE

- display touch screen da 5"
- batteria ai polimeri di lito ricaricabile
- completo di sensore da 80 bar (basse pressioni) e cavo USB

Tester digitale per la misurazione di pressione e compressione

Con kit 960AD/TP2 permette di verificare:

- compressione motori benzina e diesel
- pressione olio motore
- bassa pressione common rail
- pressione iniezione benzina

Con kit 1464AP permette di verificare:

- pressione reale circuito common rail
- pressione pompa alta pressione



novità

1464AP

014640450

~~€ 590,00~~

€ 338,00

Set di adattatori per 1464T e 960TP

- finti iniettori
- finte candele
- adattatori candela
- adattatori tappi olio
- raccordi iniezione benzina
- set guarnizioni di ricambio



Set per la verifica dell'impianto alta pressione dei motori diesel common rail, con 1464T.

- set tubi alta pressione
- raccordi di collegamento
- sensore da 2.000 bar



430x310x50 mm



430x310x50 mm

novità

1464IC

014640350

~~€ 430,00~~

€ 248,00

Set di finti iniettori e finte candele per 1464T

Permette di collegarsi al motore per la verifica della compressione nei motori diesel con tester digitale 1464T.

- n° 22 false candele
- n° 5 falsi iniettori
- n° 1 kit falso iniettore universale per truck, motori marini e macchine agricole



559x312x50 mm

novità

1498/4A

014980104

~~€ 118,00~~
€ 68,00

- selezione automatica della tensione 6 o 12 Volt
- selezione automatica del tipo di batteria



IP65

DATI TECNICI:	
Tensione di alimentazione	220V-240V
Frequenza	50-60 Hz
Corrente nominale (min-max)	1-4 Amp
Tensione della batteria	6V/12V
Capacità batteria	4Ah-80Ah
Tempo di ricarica	12 ore
Grado di protezione	IP65

- Caricabatterie elettronico**
- protezione di inversione di polarità, corto circuito
 - display digitale retroilluminato
 - gancio di fissaggio reclinabile



novità

1498/8A

014980108

~~€ 165,00~~
€ 95,00

- funzione recupero batterie scariche
- funzione alimentatore 13,8V-5A



IP65

DATI TECNICI:	
Tensione di alimentazione	220V-240V
Frequenza	50-60 Hz
Corrente nominale (min-max)	2-8 Amp
Tensione della batteria	12V
Capacità batteria	5Ah-160Ah
Funzione Memory Saver	13,8V - 5A
Grado di protezione	IP65

novità

1498/50A

014980050

~~€ 1.335,00~~
€ 775,00



Caricabatterie elettronico 12V multifunzione

Particolarmente indicato per la carica e l'alimentazione dei veicoli durante tutte le fasi di riprogrammazione e autodiagnosi

- corrente max di carica/alimentazione **50 Ampere**
- carica e recupero batterie
- alimentazione per protocolli diagnosi ECU
- gestione elettronica con microprocessore
- protezione contro inversione polarità e corto circuito



12 V / 50 A



DATI TECNICI:	
Alimentazione	230V
Tensione	12V
Corrente di carica	1-50A
Capacità di carica	5-500Ah
Capacità mantenimento	5-1500Ah
Lunghezza cavi	3m
Sezione	10 mm ²

380 mm
100 mm
220 mm

1497/C23

014970200

~~€ 165,00~~
€ 96,00

Assortimento 23 utensili per sblocco connettori elettrici

430x310x50 mm





novità

1498/40A

014980140

~~€ 895,00~~
€ 525,00



Caricabatterie avviatore multifunzione 12-24V carrellato

- 3 cicli di carica programmati e 1 ciclo manuale
- potenziometro di regolazione elettronica
- processi specifici di carica WET-SPIRAL/GEL-AGM
- sistema di controllo e protezione elettronico
- processo di carica a 10 fasi
- funzione desolfatazione e recupero batteria
- funzione supply
- doppia tensione 12-24V
- idoneo anche per batterie Start&Stop
- pinze professionali in ottone isolate in gomma



Pb Wet, Gel Dry, Agm

IP65



DATI TECNICI:

Alimentazione	230V
Tensione in uscita	12-24V
Corrente di carica	1-40A
Corrente di avviamento	350A max cc
Capacità di ricarica	4-450Ah

2 in 1
caricabatterie
+ avviatore

1498TB/12

014980400

~~€ 480,00~~
€ 278,00



Tester digitale per batteria 12V

- permette di effettuare i seguenti test: batteria, alternatore, avviamento e massa veicolo
- dotato di software per stampare il test eseguito da PC
- display retroilluminato
- struttura compatta e antiurto
- software in 10 lingue
- dotato di un apposito ingresso per il collegamento di una mini stampante estraibile (accessorio opzionale)

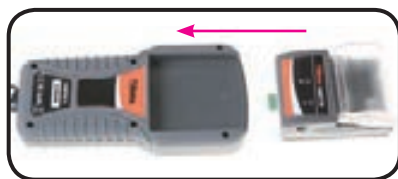

370x270x100 mm



DATI TECNICI:

- **applicazioni:** Test batterie 12V test alternatore 12V carica - Test sistemi avviamento
- **intervallo di funzionamento:** 100-1700 CCA
- **normative di riferimento:** CCA, SAE, DIN, EN, IEC, JIS
- **batterie supportate:** PB, Wet, Gel, Agm, Mf, Vrla, Sli
- **voltmetro:** 9V-15V
- **lunghezza cavi:** 180 cm
- **lingue:** Italiano, Inglese, Francese, Tedesco, Spagnolo, Polacco, Rumeno, Olandese, Svedese e Finlandese
- **accessori inclusi:** Cavo USB e software



1498ST/TB

014980410

~~€ 180,00~~
€ 105,00

Mini stampante termica per Tester 1498TB/12

- possibilità di collegare la mini stampante direttamente sul tester
- permette di stampare i risultati del test effettuato



12V

1498/12

014980480

€ 520,00

€ 295,00

Avviatore per autovetture 12 V portatile

- corrente di spunto 2200 A
- batteria ermetica al piombo electrolyte solido (AGM)



12-24V

1498/24

014980490

€ 1.050,00

€ 590,00

Avviatore per auto e veicoli commerciali 12-24 V portatile

- corrente di spunto 4200 A (12 V), 2100 A (24 V)
- batteria ermetica al piombo electrolyte solido (AGM)

novità

1498MN/12

014980000

€ 260,00

€ 148,00

Avviatore portatile multifunzione

DATI TECNICI:

Corrente di spunto	600A
Tipo di batteria	LiCoO2
Uscita per avviamento	12 Volt
Peso	1 Kg



FUNZIONI

- avviamento di veicoli con batteria 12 Volt (diesel e benzina fino a 2000 cc.)
- ricarica di tablet, telefoni cellulari e apparecchi elettronici in genere
- torcia LED multifunzione electrolyte solido (AGM)

leggero e compatto



- uscita USB per caricare dispositivi elettronici



- alimentatore da rete e da auto



- cavo USB con adattatori di ricarica

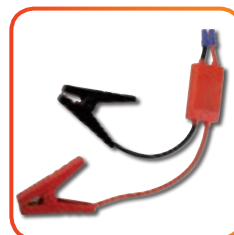

- cavi di avviamento con pinze isolate e dispositivo di protezione contro inversione di polarità e corto circuito



240x185x60 mm

960KPC

009600780

~~€ 242,50~~

€ 142,00

1 1/4"

Evita la rottura delle candele durante lo smontaggio



420x185x60 mm

Estrattore reversibile ad impulsi con coppia regolabile per candele di preriscaldamento

- l'estrattore pneumatico a coppia regolabile e le bussole speciali consentono di svitare le candele bloccate riducendo al minimo il rischio di danneggiamento
- 5 bussole da 1/4" macchina lunghe, speciali per candele: 8-9-10-11-12 mm, 2 prolunghe e 1 snodo
- 4 coppie di serraggio regolabili: 10-20-30-40 Nm
- regolazione destrorsa e sinistrorsa

960KC/M....

009600801

~~€ 295,00~~

€ 172,00

Per candele con filetto M8-M9-M10

Assortimento di utensili per la rimozione delle candele di preriscaldamento spezzate o danneggiate



380x290x50 mm



960EPC

009600790

~~€ 470,00~~

€ 275,00

Set di utensili per l'estrazione dell'elettrodo delle candele di preriscaldamento

- permette una corretta e rapida estrazione della parte terminale dell'elettrodo in caso di rottura o grippaggio all'interno della sede della candela.
- adatto per candele con filettatura: M8x1 - M9x1 - M10x1 - M10x1,25



270x230x80 mm



ZONA DI ROTTURA

novità

1462/KD

014620060

~~€ 635,00~~

€ 368,00

Assortimento utensili per estrazione iniettori Denso completo di massa battente

- indicato per iniettori Denso montati su veicoli Toyota, Nissan, Mazda, Opel e Lexus
- permette l'estrazione degli iniettori indipendentemente dai motori sui quali sono montati
- non danneggia gli iniettori

Non è necessaria la rimozione del motore



≡ 350x210x80 mm



960KI

009600235

~~€ 1.950,00~~

€ 1.130,00



Assortimento di utensili per estrazione iniettori Diesel Common Rail Permette la rimozione degli iniettori DELPHI-BOSCH-SIEMENS-DENSO

- funzionamento meccanico e idraulico
- include un martinetto idraulico da 12 tonnellate
- può essere utilizzato direttamente sul veicolo con motore montato
- le numerose possibilità di regolazione sulla testata permettono di lavorare sulla maggior parte dei motori in circolazione

≡ 590x470x140 mm



960PI/P

009600216

~~€ 248,00~~

€ 145,00

Assortimento di 14 utensili speciali e alesatori per la pulizia della sede iniettori

- INCLUSI NELL'ASSORTIMENTO:
- 3 alesatori piatti: $\varnothing 19/15$ mm - $\varnothing 17/17$ mm - $\varnothing 19/17$ mm
 - 2 alesatori ad angolo: $\varnothing 21/17$ mm - $\varnothing 17/17$ mm
 - utensile per estrazione rondella iniettore
 - spazzole per pulizia frese
 - spazzola per pulizia iniettore
 - impugnatura e accessori per l'utilizzo delle frese

≡ 373x280x61 mm

14 pezzi



novità

437K/33

004370133

~~€ 205,00~~

€ 119,00

Boccole:
M8x1,0 - M10x1,0 - M10x1,25 - M12x1,25
Maschi:
M8x1,0 - M10x1,0 - M10x1,25 - M12x1,0
M12x1,25 - M14x1,25

Assortimento per il ripristino
delle filettature candele danneggiate



≡ 210x150x50 mm

1477/C10

014770310

~~€ 120,00~~

€ 69,00



Assortimento di 9 inserti e
1 chiave curva per dadi
tendinghia
in cassetta di plastica

- 1 chiave curva con attacco per inserti
- 4 inserti poligonali doppi:
○ 12x14 - 13x15 - 16x17 - 18x19 mm
- 5 inserti per viti con profilo Torx:
⊗ E10 - E12 - E14 - E16 - E18



≡ 530x110x55 mm

1758VT

017580100

~~€ 129,00~~

€ 75,00

Kit per la verifica delle testate

Grazie al liquido di contrasto
è possibile verificare velocemente
se nella vaschetta d'espansione
è presente anidride carbonica.



≡ 290x190x50 mm

novità

1759HD/TRUCK

017590065

~~€ 298,00~~
€ 175,00

Strumento per controllo e tenuta impianto di raffreddamento Truck

Descrizione componenti

- 1 tappo con attacco a baionetta Ø 56 mm
- 1 tappo filettato Ø 39 mm
- 1 tappo filettato Ø 43 mm passo grosso
- 1 tappo filettato Ø 43 mm passo fine
- 1 tappo filettato Ø 49 mm
- 1 tappo filettato Ø 59 mm
- 1 tappo filettato Ø 69 mm



440x330x100 mm



1759TT

017590300

~~€ 155,00~~
€ 91,00

Kit 4 coppie tappi per verifica circuito turbo utilizzabile con pistole gonfiagomme

il kit comprende:

- 1 coppia tappi misure 35-40-45 mm
- 1 coppia tappi misure 50-55-60 mm
- 1 coppia tappi misure 65-70-75 mm
- 1 coppia tappi misure 80-85-90 mm
- 1 valvola di sovrappressione



400x160x100 mm



1759HD/3

017590063

~~€ 430,00~~
€ 250,00

Strumenti per controllo tenuta impianto di raffreddamento e riempimento circuito

Permette di verificare sotto pressione le perdite del circuito (tubi, giunti, pompe, radiatori) e riempire velocemente il circuito evitando la formazione di bolle d'aria.

600x500x140 mm



1482

014820001

~~€ 80,00~~
€ 47,00

Chiave regolabile autoserrante per ghiere galleggianti serbatoio



Ø mm 89÷170



novità

3012C

030120255

~~€ 640,00~~
€ 350,00

Staffa sostegno motore inferiore

Ideale per auto e veicoli commerciali

permette maggiore rapidità negli interventi di sostituzione:

- cinghia distribuzione
- pompa dell'acqua
- alternatore

Dati tecnici:

- portata max: 250 kg
- lunghezza: 1050 mm
 - altezza: 120 mm
 - altezza massima sollevatore: 260 mm
 - peso: 12 kg



Vantaggi

- applicabile in pochi secondi dall'operatore con fissaggio nel sottoscocca
- include 2 coppie di perni stabilizzatori per poter operare su vetture, furgoni e veicoli commerciali
- cinghia da carico per poter stabilizzare la traversa in assenza dei fori sul telaio

novità

1480

014800010

~~€ 285,00~~
€ 167,00

Kit riempimento filtri gasolio per auto senza pompa elettrica

Utilizzabile anche con pistola gonfiagomme



Il kit include:

- attacchi rapidi GM
- attacchi rapidi Renault, GM, Fiat Ø interno 6 mm
- attacchi rapidi Renault, GM, Fiat Ø interno 7 mm
- attacchi rapidi Ford
- attacchi rapidi PSA Ø interno 6 mm
- attacchi rapidi PSA Ø interno 7 mm
- attacchi rapidi Ford
- 2 adattatori conici per vetture senza attacchi rapidi

410x320x70 mm

novità

1758A

017580010

~~€ 58,00~~
€ 34,00



**Imbuto antiriflusso
con attacco rapido Ø 38 mm**
Particolarmente indicato
per vetture
del gruppo Volkswagen



- indicatore di livello
- coppa di grande diametro con griglia scolafiltro capacità 12l
- svuotamento pneumatico del serbatoio con tubo da 1,8 m
- vaschetta portautensili

novità



1877A

018770080

~~€ 990,00~~
€ 568,00

**Recuperatore/aspiratore
olio esausto, carrellato
con serbatoio da 90 litri
e precamera**

- precamera trasparente
capacità 9,5l
- tubo aspirazione da 1,8 m

In dotazione:

- 1 sonda rigida Ø 5x700 mm
- 1 sonda flessibile Ø 5x700 mm
- 1 sonda rigida Ø 6x600 mm
- 1 sonda flessibile Ø 6x700 mm
- 1 sonda flessibile Ø 7x700 mm
- 1 sonda flessibile Ø 8x700 mm
- adattatori per VW, BMW, CITROËN,
MERCEDES



1877

018770008

~~€ 560,00~~
€ 320,00

**Recuperatore olio esausto
carrellato con serbatoio
da 90 litri**



1493/C19

014930019

~~€ 170,00~~

€ 98,00

38"

12"

Serie di 18 chiavi a bussola per filtri olio

- N° 6 bussole esagonali misura 24-27-30-32,5-36-38 mm per cartucce filtro
- Il kit include 1 chiave regolabile universale Ø 58÷93 mm

Misure incluse nella serie:

Ø mm	N lati
63-64	14
66,5	14
74	14
79	15
84	14
87	16
92	15
94,5	15
100,5	15
64,5	14 a settori per Toyota
64,5	14 a settori per Lexus



1368

013680001

~~€ 310,00~~

€ 180,00



Kit ripara plastiche

- alimentazione 220÷240 V con presa Shuko
- lunghezza cavo pistola termica 3,5 m
- lunghezza cavo alimentazione 1,35 m
- 2 regolazioni di potenza 35-75 W
- pistola termica con terminali in ottone a 2 angolazioni di inserimento graffetta: 0°-90°
- protezione input: disgiuntore termico
- protezione output: fusibile 10 A
- tasca metallica per riporre la pistola
- fornito senza graffette

Permette di riparare velocemente crepe e rotture di parti in plastica



1368G/K400

013680140

~~€ 48,00~~

€ 28,00

Assortimento di 400 graffette per 1368

In dotazione:

- 100 graffette a serpentina piccola
- 100 graffette a serpentina grande
- 100 graffette per angoli concavi
- 100 graffette per angoli convessi

1479/B27

014790407

~~€ 55,00~~

€ 32,00

Kit di 27 attrezzi in nylon per pioli e interventi su plastiche e guarnizioni



1884

018840010

~~€ 360,00~~
€ 208,00

7,5 l

Attrezzo per l'inserimento di olio nei cambi manuali, automatici e nei differenziali

- Completo di 12 adattatori per la connessione diretta
- dotato di valvola di non-ritorno per un'efficace azione di inserimento dell'olio senza perdite
 - portata: 70 cc a pompata
 - capacità serbatoio: 7,5 litri
 - massima viscosità olio utilizzabile: SAE 140



12 ADATTATORI

FORD	AT-101
UNIVERSAL (Bmw, Honda, Nissan...)	AT-102
VW-AUDI	AT-103
VW-AUDI-PORSCHE	AT-104
VW-AUDI-MINI COOPER	AT-105
MERCEDES	AT-106
DSG	AT-107
VW-AUDI CVT	AT-108
VOLVO	AT-109
TOYOTA-LEXUS	AT-110
SKODA	AT-111
VW Passat/Tiguan <2007	AT-112

1569/A

015690011

~~€ 780,00~~
€ 450,00

Assortimento di utensili per l'estrazione e l'introduzione dei silent block ponte posteriore, paraoli albero motore e cuscinetti ruota

- le boccole possono essere utilizzate sia direttamente sul veicolo che alla pressa idraulica
- estrazione diretta con chiave
- facilità di utilizzo, non servono macchine pneumatiche o idrauliche
- il kit comprende:
4 barre filettate: M10-M12-M14-M16
4 rondelle
boccole per diametri da 44 a 82 mm

530x415x115 mm



1569/F

015690021

~~€ 325,00~~
€ 190,00

novità



Assortimento di utensili per l'estrazione e l'introduzione dei silent block di Fiat Panda, Panda 4x4, Panda Metano e Cross, Fiat 500, Ford Ka e Opel Adam



270x230x80 mm

1530/C5

015300300

~~€ 410,00~~
€ 238,00

Kit per estrazione mozzi e cuscinetti ruote a 3, 4, 5 fori

Il kit comprende:

- 1 flangia universale 96÷138 mm
- 1 vite idraulica da 12 tonnellate
- 1 massa battente da 2,8 kg indispensabile per mozzetti senza bullone di fissaggio centrale

novità

1473P

014730020

~~€ 22,00~~
€ 12,80

Pinza per collari OETIKER® pinzabili a basso profilo



760x320x120 mm



1471M/C22

014710101

~~€ 225,00~~
€ 127,00

Utensile pneumatico per arretrare e ruotare i pistoncini dei freni a disco destrorsi e sinistrorsi con accessori in valigetta di plastica



novità

437K/16

004370016

~~€ 82,00~~
€ 48,00

Assortimento per il ripristino delle filettature danneggiate dei supporti pinze freno M9x1,25

- martinetto automatico
- 150 kg di spinta
- pressione di utilizzo 5÷8 bar



350x310x85 mm



210x150x50 mm

novità

720MRC

007200631

~~€ 14,00~~

€ 8,00

12"

Chiave a bussola Macchina con inserto polimerico per vite ruota con profilo Mercedes Ø 17mm



Adatta per i modelli Mercedes:

- Classe C e GLK (W204)
- Classe E (W211, W212, W207)
- Classe SLK (W172)
- Classe ML (W164, W166)
- Classe CL (W216)
- Classe S (W221, W222)



novità

971/C8

009710108

~~€ 297,00~~

€ 172,00

Giravite dinamometrico con accessori per il serraggio controllato delle valvole dei pneumatici con sistema di controllo della pressione



335x145x60 mm



	583/6	1,2÷6 Nm
	892/0	
	862TX	T10-T15-T20
	900L	11-12 mm
	986 78	

novità

971TSP

009710025

~~€ 965,00~~

€ 535,00

Include oltre 50 marche di veicoli



Lo strumento dispone di una banca dati che supporta le operazioni di riparazione come:

- coppie di serraggio
- codici di ricambio originali e di sensori universali compatibili

1° anno di aggiornamenti incluso

Strumento per sensori di pressione dei pneumatici

lettura delle informazioni dai sensori TPMS quali:

- ID del sensore
- pressione di gonfiaggio
- temperatura
- stato batteria
- attivazione dei sensori
- programmazione sensori universali

DATI TECNICI:

Processore	Cortex M0+, 48 MHz
Display	1,5" LCD retroilluminato
Risoluzione	64x128 pixels
Comunicazione via cavo	USB
Comunicazione Wireless	Bluetooth classe 2 con antenna integrata
Batteria	Tipo Li-ion, Capacità 1100 mAh, Tensione 3,7V
Autonomia	circa 8 ore
Ricarica	via USB, circa 3 ore
Aggiornamenti	è previsto un servizio di aggiornamento periodico della banca dati veicoli dopo il primo anno



3010T

Coppia di cavalletti
in acciaio



H

	Max kg	H min mm	H Max mm		€	€
3010/T2	2000	280	425	030100002	€ 75,00	€ 44,00
3010/T3	3000	285	430	030100003	€ 90,00	€ 53,00
3010/T6	6000	400	580	030100006	€ 130,00	€ 76,00
3010/T10	10000	471	735	030100010	€ 220,00	€ 128,00

novità

1567

015670001

~~€ 245,00~~
€ 143,00

Leva per estrazione testine braccio oscillante
e ammortizzatori dal montante

Un solo operatore riesce senza sforzo
a posizionare la leva e a procedere
al disassemblaggio



1550/2

015500002

~~€ 2.050,00~~
€ 1.150,00

Compressore pneumatico
per molle ammortizzatori
Mac Pherson
ed equivalenti

- pressione di utilizzo: 6÷8 bar
- spinta massima a 6,2 bar: 800 kg
- spinta massima a 8 bar: 975 kg
- corsa del pistone: 255 mm
- fornito con 3 griffe per diametri 90÷205 mm e 1 morsa regolabile



Consumo aria
medio 225 l/min

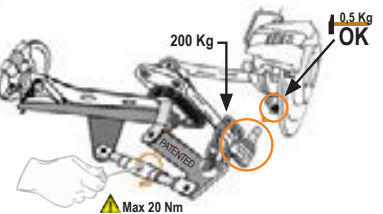
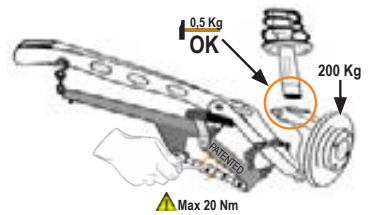

3030/2T

030300020

€ 595,00

€ 335,00

Sollevatore idraulico ribassato 2 t a 6 ruote

- ottima manovrabilità del sollevatore su pavimentazioni sconnesse e irregolari
- altezza minima piattello: 85 mm
- altezza massima piattello: 520 mm
- lunghezza: 860 mm
- larghezza: 400 mm
- doppie ruote anteriori basculanti in materiale plastico (PTFE)
- portata massima: 2 tonnellate
- il pedale permette un rapido avvicinamento



H max
520 mm



stabile e maneggevole

2t

H min
85 mm



Il pedale permette un rapido avvicinamento



Doppie ruote anteriori basculanti in materiale plastico (PTFE) con cuscinetti

novità

3063/2,5T

030630025

€ 1.620,00

€ 930,00

Sollevatore oleopneumatico a carrello da 2,5 tonnellate

Particolarmente indicato per l'utilizzo su autovetture e veicoli commerciali. Ideale per officine, gommisti e carrozzerie

Dotato di:

- rientro automatico del braccio
- controllo velocità a pieno carico

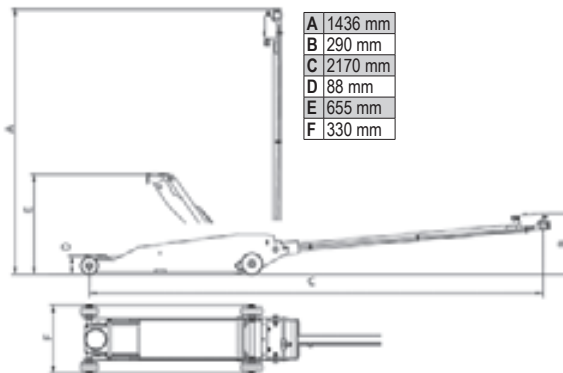

2,5t

Dati tecnici:

- portata: 2,5t
- peso: 75 kg
- pressione di alimentazione: 8-10 bar
- consumo d'aria: 400 l/min



novità

3065/40-20T

030650200

€ 2.320,00

€ 1.320,00



**Sollevatore oleopneumatico
40-20 tonnellate**

- indicato per utilizzo su mezzi pesanti
- pratico e maneggevole per trasporto anche su officine mobili
- rientro automatico dei pistoni
- due valvole di discesa con controllo velocità sotto carico

Dati tecnici:

- portata: 40/20 tonnellate
- peso: 39 kg
- pressione di alimentazione: 8-10 bar
- consumo d'aria: 400 l/min

A	1400 mm
B	1320 mm
C	525 mm
D	270 mm
E	150 mm
F	78 mm
G	72 mm
H	150 mm
K	206 mm
L	300 mm
M	20 t
N	40 t

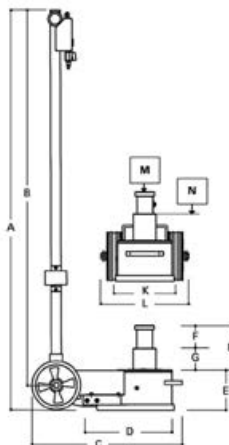

novità

3067/70-13T

030670130

€ 4.350,00

€ 2.480,00



Sollevatore oleopneumatico 70-43-23-13 t

Versione lunga, adatta all'utilizzo su autocarri, autoarticolati, autobus e macchine agricole

- rientro automatico dei pistoni
- due valvole di discesa con controllo velocità sotto carico

Dati tecnici:

- portata: 70-43-23-13 tonnellate
- peso: 74 kg
- pressione di alimentazione: 8-10 bar
- consumo d'aria: 600 l/min

A	1430 mm
B	1320 mm
C	1000 mm
D	320 mm
E	150 mm
F	250 mm
G	60 mm
H	68 mm
L	56 mm
M	66 mm
N	350 mm
O	240 mm
P	70 t
Q	43 t
R	23 t
S	13 t

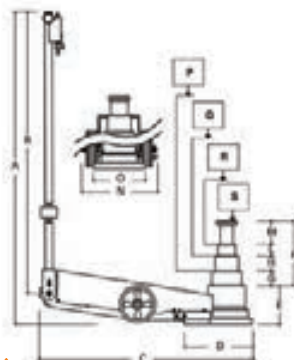

novità

3061/2T

030610020

~~€ 685,00~~
€ 390,00

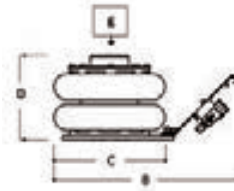

B	415 mm
C	250 mm
D	132-326 mm
E	2 t

Dati tecnici:

- portata: 2 t
- peso: 14 kg
- pressione di alimentazione: 8-10 bar
- altezza: min. 132 - max. 326 mm



**Sollevatore pneumatico
2 tonnellate - 2 stadi**

Dotato di:

- membrana ad alta resistenza e guida telescopica interna
- dispositivo d'arresto a fine corsa e valvola di sicurezza per carichi eccessivi
- possibilità di utilizzo anche sui ponti sollevatori



3025

030250001

~~€ 1.465,00~~
€ 845,00

3025/PF

030250011

~~€ 235,00~~
€ 135,00

Pinza movimentazione fusti



**4 posizioni di carico:
450-650-800-1000 kg**



**Gru idraulica pieghevole
con pompa a doppio effetto**

- portata massima: 1 t
- la struttura richiudibile riduce al minimo gli ingombri
- con valvola limitatrice di carico e stelo cromato
- velocità di discesa controllata
- ruote in nylon
- altezza massima: 2400 mm
- dimensioni: 1560 x 1000 mm

**Portata massima
300 kg**



300 Kg

3026 0,3

030260003

~~€ 540,00~~
€ 305,00

- portata massima: 300 kg
- pompa a pedale
- stelo cromato
- ruote in nylon
- altezza minima: 1120 mm
- altezza massima: 1970 mm

Sollevatori idraulici da fossa e sottoponte



novità

3026/SP

030260505

~~€ 530,00~~
€ 310,00

Supporto universale per trasmissioni
Permette ad un solo operatore di smontare e rimontare le trasmissioni di autovetture, veicoli commerciali e fuoristrada con rapidità e sicurezza.



- adatto per steli con diametro: 25-30-35-45 mm
- portata massima: 150 kg
- altezza: 250 mm
- inclinazione: 45°
- peso: 10 kg



500 Kg

3026 0,5

030260005

~~€ 640,00~~
€ 375,00

- portata massima: 500 kg
- pompa a pedale
- stelo cromato
- valvola limitatrice di carico
- ruote in nylon
- altezza minima: 1140 mm
- altezza massima: 1990 mm



30145AR

030140360

~~€ 1.040,00~~
€ 598,00

Cavalletto sostegno motore richiudibile

Portata massima: 450 kg

- facilmente richiudibile con notevole riduzione degli ingombri
- permette la rotazione di 360° del motore o del cambio
- garantisce la massima sicurezza e stabilità durante gli interventi



360°

1000 mm
920 mm
1145 mm

3027 20

030270020

~~€ 1.790,00~~

€ 1.025,00



Pressa idraulica con pistone mobile

- pompa manuale a 2 velocità
- pistone mobile
- stelo cromato
- ritorno automatico del pistone
- sicurezza idraulica in caso di sovraccarico
- manometro
- serie prismi a V inclusi

Capacità massima: 20 t

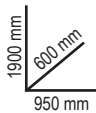

3027/KP20

030270520

~~€ 380,00~~

€ 220,00

Serie di cacciaspine e piastra per pressa 3027 20

Ø cacciaspine: 5-10-14-18-24-29 mm

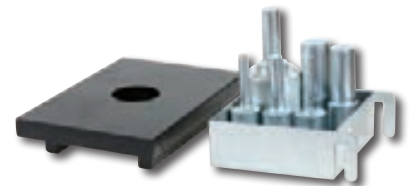

3027/KP50

030270550

~~€ 460,00~~

€ 268,00

Serie di cacciaspine e piastra per pressa 3027 50

Ø cacciaspine: 5-10-14-18-24-29 mm

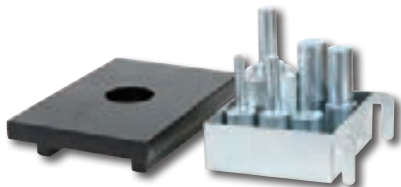

3027 50

030270050

~~€ 4.290,00~~

€ 2.480,00

Pressa idraulica con pistone mobile e argano

- pompa manuale a 2 velocità
- pistone mobile
- stelo cromato
- ritorno automatico del pistone
- manometro
- serie prismi a V inclusi

Capacità massima: 50 t

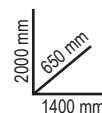

3027/KPP50

030270555

~~€ 190,00~~

€ 110,00

Comando a pedale per pressa idraulica 3027-50 e 3027-20



novità

3007

030070001

~~€ 410,00~~

€ 240,00

- 4 ruote pivotanti, di cui 2 con freno, adatte all'uso in forno di verniciatura
- 2 supporti scorrevoli per adattarsi a tutti i telai
- portata massima 800 kg

Carrello sottoscocca per veicoli senza meccanica anteriore/posteriore
 Permette di movimentare agevolmente i veicoli privi di avantreno o retrotreno durante le fasi di lavorazione

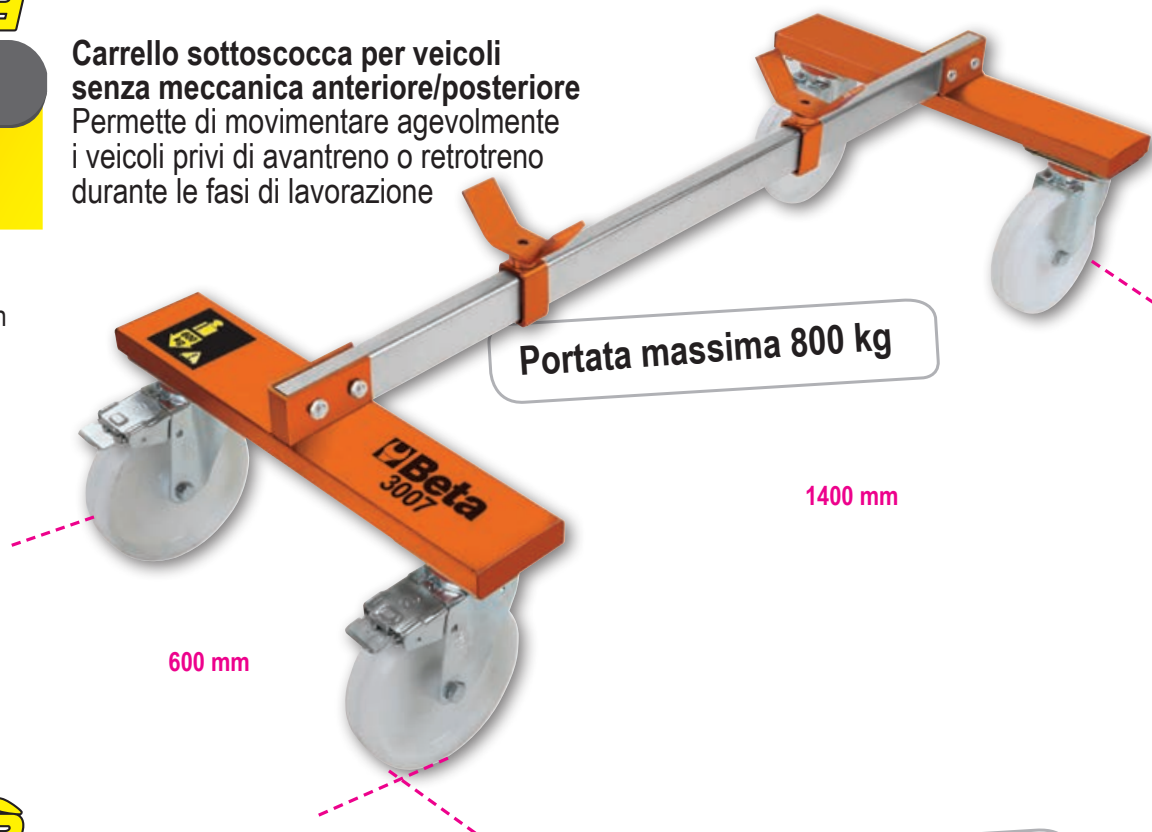

novità

3008

030080100

~~€ 2.450,00~~

€ 1.390,00

Sollevatore e posizionatore ruote Truck singole e gemellari

- portata massima 700 kg
- altezza minima 140 mm
- altezza massima 660 mm
- interasse rulli 470÷740 mm
- sicurezza idraulica in caso di sovraccarico
- ruote anteriori pivotanti

Oltre all'utilizzo convenzionale risulta particolarmente utile per rimuovere e riposizionare serbatoi e paraurti



3002

030020001

~~€ 81,00~~
€ 47,00

Letto sottomacchina e seggiolino

- struttura in acciaio
- rivestimento in PVC con imbottitura
- possibilità di regolare la posizione rapidamente: lettino o seggiolino



2 prodotti in 1:
lettino o seggiolino

3003

030030001

~~€ 62,00~~
€ 36,00

Letto sottomacchina in plastica antiurto



Ø ruote: 76 mm

120 mm

3009

030090001

~~€ 325,00~~
€ 192,00

Carrello per movimentazione veicoli

- Portata massima: 550 kg
- 4 rulli basculanti
 - larghezza rulli 200 mm
 - per ruote fino a 240 mm di larghezza

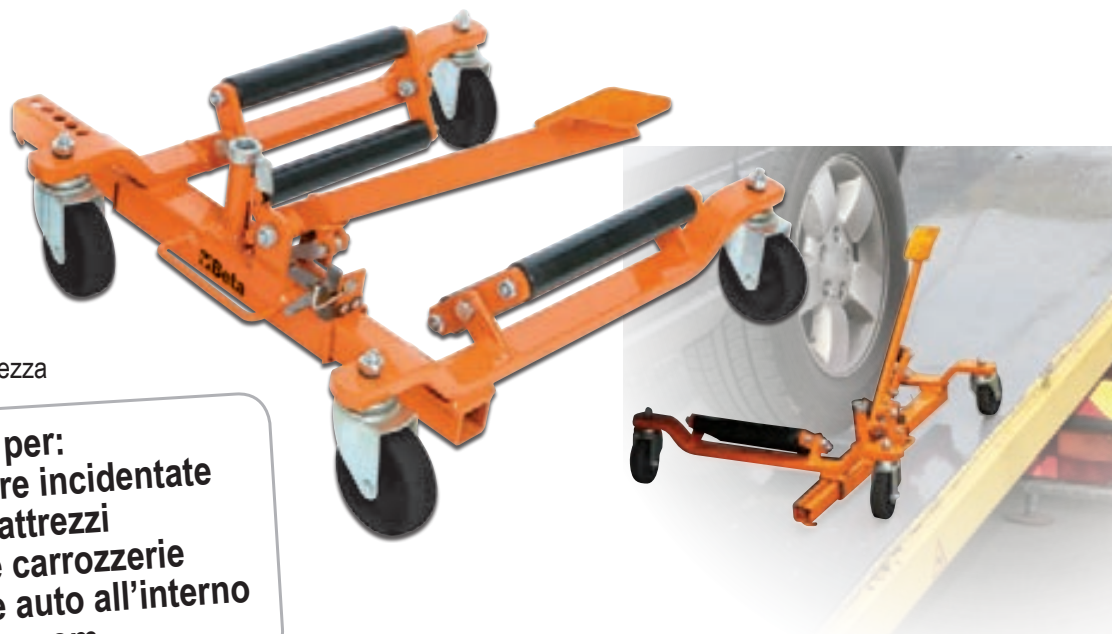

- Ideale per:**
- recupero vetture incidentate su carro attrezzi
 - autofficine e carrozzerie
 - movimentazione auto all'interno di show room

**Super compatto e potente
770 Nm**

novità
1927XM/K5
019270129
~~€ 266,00~~
€ 153,00

12"



Assortimento di un avvitatore reversibile compatto e 5 bussole Macchina,

- in valigetta di plastica
- Meccanismo impulsivo singolo martello
- Incredibilmente compatto e potente
- Comando d'inversione a pulsante azionabile con una sola mano
- Tre differenti livelli di potenza in avvitamento
- Scarico dell'aria attraverso l'impugnatura
- Gancio per bilanciatore



307x206x86 mm

1,3 kg

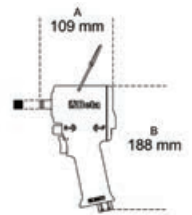

Velocità libera	giri/min	10.000
Massa battente		Singolo martello
Coppia massima	Nm	770
Capacità vite/dado	Cl 8.8	M22●34 mm
Capacità vite/dado	Cl 12.9	M18●27 mm
Attacco aria	GAS	1/4"
Pressione di utilizzo	Bar	6,2
Ø tubo consigliato	mm	10
Consumo aria medio	l/min	122

○ 720 17-19-21-22-24 mm

1927CD
019270007
~~€ 355,00~~
€ 205,00

12"



Avvitatore reversibile in materiale composito

- Meccanismo impulsivo doppio martello
- Leggero e bilanciato per un facile utilizzo
- Dotato di un'elevata coppia
- Comando d'inversione a leva
- Tre differenti livelli di potenza in avvitamento
- Scarico dell'aria attraverso l'impugnatura
- Silenziato



1,9 kg

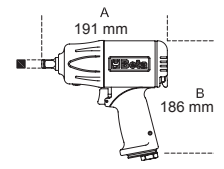

Velocità libera	giri/min	7.000
Massa battente		Doppio Martello
Coppia massima	Nm	1.020
Capacità vite/dado	Cl 8.8	M22●34mm
Capacità vite/dado	Cl 12.9	M18●27mm
Attacco aria	GAS	1/4"
Pressione di utilizzo	Bar	6,2
Ø tubo consigliato	mm	10
Consumo aria medio	l/min	130

1927P
019270008
~~€ 395,00~~
€ 228,00

12"



Avvitatore reversibile in materiale composito

- Meccanismo impulsivo doppio martello
- Leggero e bilanciato per un facile utilizzo
- Comando d'inversione a leva
- Tre differenti livelli di potenza in avvitamento
- Scarico dell'aria attraverso l'impugnatura
- Impugnatura antivibrazioni



2 kg

**Super potente
1750 Nm**

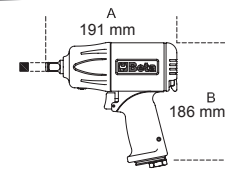

Velocità libera	giri/min	7.500
Massa battente		Doppio Martello
Coppia massima	Nm	1.750
Capacità vite/dado	Cl 8.8	M24●36 mm
Capacità vite/dado	Cl 12.9	M20●30 mm
Attacco aria	GAS	1/4"
Pressione di utilizzo	Bar	6,2
Ø tubo consigliato	mm	10
Consumo aria medio	l/min	290



Utensili Pneumatici



1928K4

019280104

~~€ 635,00~~
€ 365,00

3/4"



Assortimento di un avvitatore reversibile e 4 bussole Macchina serie lunga, in valigetta di plastica

- Meccanismo multiplo "Pin Clutch"
- Tre differenti livelli di potenza in avvitamento e svitamento
- Impugnatura antiscivolo
- Comando d'inversione a leva
- Scarico dell'aria attraverso l'impugnatura

5,2 kg

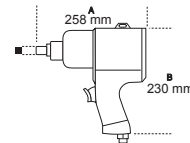

Velocità libera	giri/min	4.000
Massa battente		Pin Clutch
Coppia massima	Nm	1.493
Capacità vite/dado	Cl 8.8	M27●41mm
Capacità vite/dado	Cl 12.9	M24●36mm
Attacco aria	GAS	3/8"
Pressione di utilizzo	Bar	6,2
Ø tubo consigliato	mm	10
Consumo aria medio	l/min	260
Peso kit	kg	9,3

410x330x106 mm

728L 27-30-32-36 mm



1928DA

019280022

~~€ 615,00~~
€ 355,00

3/4"



Avvitatore reversibile

- Meccanismo impulsivo doppio martello
- Robusto e compatto, dotato di un'elevata coppia
- Comando d'inversione a leva
- Tre differenti livelli di potenza in avvitamento e svitamento
- Scarico dell'aria attraverso l'impugnatura
- Impugnatura ergonomica antiscivolo

4,3 kg

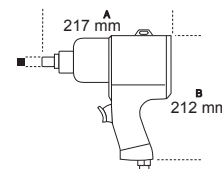

Velocità libera	giri/min	5.000
Massa battente		Doppio martello
Coppia massima	Nm	1.695
Capacità vite/dado	Cl 8.8	M27●41mm
Capacità vite/dado	Cl 12.9	M24●36mm
Attacco aria	GAS	3/8"
Pressione di utilizzo	Bar	6,2
Ø tubo consigliato	mm	10
Consumo aria medio	l/min	240



1928CD

019280007

~~€ 798,00~~
€ 460,00

3/4"



Avvitatore reversibile in materiale composito

- Meccanismo impulsivo doppio martello
- Elevato rapporto peso/potenza
- Comando d'inversione a leva
- Tre differenti livelli di potenza in avvitamento
- Scarico dell'aria attraverso l'impugnatura
- Silenziato

3,5 kg

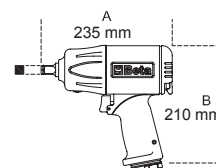

Velocità libera	giri/min	4.500
Massa battente		Doppio martello
Coppia massima	Nm	1.800
Capacità vite/dado	Cl 8.8	M27●41mm
Capacità vite/dado	Cl 12.9	M24●36mm
Attacco aria	GAS	3/8"
Pressione di utilizzo	Bar	6,2
Ø tubo consigliato	mm	10
Consumo aria medio	l/min	215



1930PA

019300032

~~€ 930,00~~

€ 535,00



Avvitatore reversibile

- Estremamente compatto
- Dotato di maniglia ausiliaria
- Comando d'inversione a leva
- Tre differenti livelli di potenza in avvitamento e svitamento
- Scarico dell'aria attraverso l'impugnatura



9,6 kg

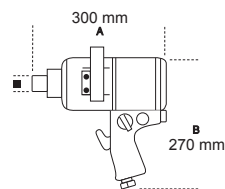

Velocità libera	giri/min	3.500
Massa battente		Doppio martello
Coppia massima	Nm	2445
Capacità vite/dado	Cl 8.8	M36●55mm
Capacità vite/dado	Cl 12.9	M30●46mm
Attacco aria	GAS	1/2"
Pressione di utilizzo	Bar	6,2
Ø interno tubo aria	mm	13
Consumo aria medio	l/min	350



1930HLA

019300040

~~€ 1.350,00~~

€ 780,00



Avvitatore reversibile

- Dotato di maniglia ausiliaria
- Comando d'inversione a leva
- Tre differenti livelli di potenza in avvitamento
- Scarico dell'aria posto nella parte superiore del corpo

**Alta coppia
3661 Nm**



16,4 kg

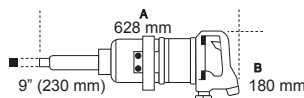

Velocità libera	giri/min	3.000
Massa battente		Doppio martello
Coppia massima	Nm	3661
Capacità vite/dado	Cl 8.8	M42●65mm
Capacità vite/dado	Cl 12.9	M33●50mm
Attacco aria	GAS	1/2"
Pressione di utilizzo	Bar	6,2
Ø interno tubo aria	mm	13
Consumo aria medio	l/min	460



1930ZL

019300070

~~€ 1.750,00~~

€ 1.010,00



Avvitatore reversibile

- Meccanismo impulsivo doppio martello
- Dotato di maniglia ausiliaria
- Comando d'inversione a leva
- Tre differenti livelli di potenza in avvitamento
- Scarico dell'aria posto nella parte superiore del corpo

4068 Nm



15 kg

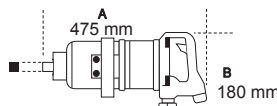

Velocità libera	giri/min	3.000
Massa battente		Doppio martello
Coppia massima	Nm	4068
Capacità vite/dado	Cl 8.8	M42●65mm
Capacità vite/dado	Cl 12.9	M36●55mm
Attacco aria	GAS	1/2"
Pressione di utilizzo	Bar	6,2
Ø interno tubo aria	mm	13
Consumo aria medio	l/min	480

BETA
1927AN
 019270012
~~€ 385,00~~
€ 223,00



Velocità libera	giri/min	4.700
Massa battente		Singolo martello
Coppia massima	Nm	244
Capacità vite/dado	Cl 8.8	M14●21mm
Capacità vite/dado	Cl 12.9	M12●19mm
Attacco aria	GAS	1/4"
Pressione di utilizzo	Bar	6,2
Ø interno tubo aria	mm	10
Consumo aria medio	l/min	190

Avvitatore reversibile angolare

- Meccanismo impulsivo singolo martello
- Dotato di un'elevata coppia
- Comando d'inversione a leva
- Due differenti livelli di potenza in avvitamento
- Scarico dell'aria attraverso l'impugnatura

2,1 kg

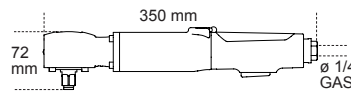

La potenza di un avvitatore nel corpo di un cricchetto

1921 I
 019210035
~~€ 260,00~~
€ 150,00



1,3 kg

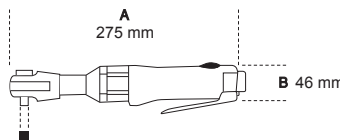

Cricchetto reversibile a coppia elevata

- Meccanismo impulsivo "Pin Clutch"
- Coppia elevata
- Coppia di reazione notevolmente ridotta
- Molto più rapido dei cricchetti convenzionali
- Impugnatura ergonomica in gomma
- Scarico posteriore dell'aria
- Scarico dell'aria attraverso l'impugnatura

Velocità libera	giri/min	400
Massa battente		Pin Clutch
Coppia massima	Nm	101
Capacità vite/dado	Cl 8.8	M10●16mm
Capacità vite/dado	Cl 12.9	M8●13mm
Attacco aria	GAS	1/4"
Pressione di utilizzo	Bar	6,2
Ø interno tubo aria	mm	10
Consumo aria medio	l/min	235

BETA
1946C4,8
 019460006
~~€ 465,00~~
€ 268,00



1,5 kg

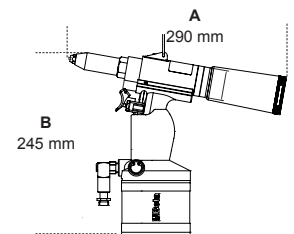

Rivettatrice con aspirazione automatica

- Per impiego con rivetti in acciaio, acciaio inox, alluminio e rame, da 2,4 - 3,2 - 4,0 - 4,8 mm
- Becco conico a punta
- Potente e maneggevole, con impugnatura in composito
- Completa di serbatoio portasteli e siringa per la lubrificazione

Materiale/rivetto	2,4	3,2	4	4,8
Rame	✓	✓	✓	✓
Alluminio	✓	✓	✓	✓
Acciaio	✓	✓	✓	✓
Acciaio Inox	✓	✓	✓	✓

Potenza di trazione	N	8.900
Lunghezza della corsa	mm	15
Capacità massima rivetti	Ø acciaio inox	4,8 mm
Attacco aria	GAS	1/4"
Pressione di utilizzo	Bar	6,2
Ø interno tubo aria	mm	10
Consumo aria	l/ciclo	2,6

1933 I

019330005

~~€ 116,00~~
€ 67,00



670 g

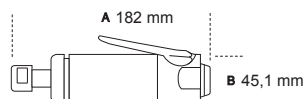

Smerigliatrice assiale

- Indicata per lavori gravosi e prolungati grazie all'elevata potenza
- Corpo ed impugnatura in materiale antiscivolo
- Montata su cuscinetti a sfera
- Regolatore di velocità mediante manopola
- Attacco aria girevole
- Scarico dell'aria posteriore silenziato
- Leva di sicurezza a scatto
- Fornita con pinza da 3 e 6 mm

Velocità libera	giri/min	20.000
Capacità pinza	mm	3-6
Potenza	kW	0,38
Attacco aria	GAS	1/4"
Pressione di utilizzo	Bar	6,2
Ø interno tubo aria	mm	10
Consumo aria medio	l/min	260



1937

019370001

~~€ 355,00~~
€ 205,00



860 g

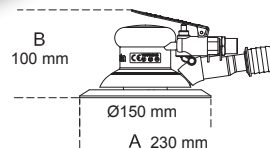

Levigatrice rotorbitale palmare senza lubrificazione in composito

- Non necessita di lubrificazione
- Estremamente compatta e maneggevole
- Diametro orbita 5 mm
- Platorello con velcro a 6 fori
- Regolazione in continuo della velocità del motore
- Impugnatura in morbido materiale antiscivolo
- Predisposta per la connessione a sistemi di aspirazione con raccordo girevole
- Scarico dell'aria orientabile

Velocità libera	giri/min	12.000
Potenza	kW	0,18
Dimensione platorello	mm	150
Diametro orbita	mm	5
Filettatura albero		5/16"-24
Attacco aria	GAS	1/4"
Pressione di utilizzo	Bar	6,2
Ø interno tubo aria	mm	10
Consumo aria medio	l/min	170

novità

1937/KL

019370161

~~€ 240,00~~
€ 122,00



750 g



Velocità libera	giri/min	3.200
Potenza	kW	0,25
Dimensione platorello	mm	75
Filettatura albero		M6
Attacco aria	GAS	1/4"
Pressione di utilizzo	Bar	6,2
Ø interno tubo aria	mm	10
Consumo aria medio	l/min	91
Peso lucidatrice	Kg	0,75
Peso kit	Kg	1,8

Mini lucidatrice orbitale

- Fornita con un platorello di levigatura da 75 mm, due spugne di lucidatura da 90mm e una lana d'agnello da 90 mm
- Impugnatura a pistola
- Regolatore di potenza variabile
- Compatta e leggera
- Adatta per la lucidatura dei fanali
- Perfetta per le riparazioni in spazi ristretti

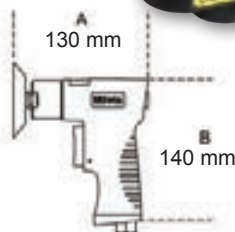

340x300x85 mm

novità

1940E10

019400010

~~€ 155,00~~
€ 90,00



1,7 kg

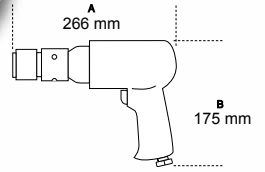

Martello scalpellatore

- Compatibile con scalpelli con attacco esagonale da 10mm
- Permette di tagliare lamiera, viti e carrozzerie, rimuovere punti di saldatura, rivetti, intonaci e piastrelle
- Fornito con molla di ritegno e trattenitore di sicurezza a baionetta
- Controllo preciso della velocità tramite pulsante
- Impugnatura ergonomica e antiscivolamento per il miglior equilibrio
- Scarico dell'aria attraverso l'impugnatura

Colpi al minuto		2900
Dimensione attacco	○ mm	10
Dimensione pistone	mm	19
Corsa del pistone	mm	67
Attacco aria	GAS	1/4"
Pressione di utilizzo	Bar	6,2
Ø interno tubo aria	mm	10
Consumo aria medio	l/min	76

1932B10

019320040

~~€ 140,00~~
€ 81,00



1,2 kg

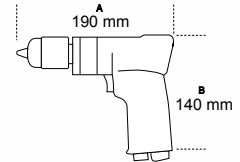

Trapano reversibile

- Robusto e maneggevole
- Mandrino di precisione autoserrante
- Invertitore di rotazione a leva
- Impugnatura antiscivolo
- Scarico dell'aria attraverso l'impugnatura

Velocità libera	giri/min	1800
Capacità mandrino	mm	1+10
Potenza	kW	0,23
Filettatura albero		3/8" -24UNF
Attacco aria	GAS	1/4"
Pressione di utilizzo	Bar	6,2
Ø interno tubo aria	mm	10
Consumo aria medio	l/min	160

1901T/10

019010210

~~€ 235,00~~
€ 135,00



6,5 kg



Avvolgitubo automatico corpo in materiale plastico antiurto per aria compressa o acqua fredda

- Pressione di utilizzo massima 15 Bar
- Tubo in pvc, Ø 10 mm
- Staffa di fissaggio metallica, orientabile
- Dispositivo automatico di arresto del tubo alla lunghezza desiderata

Attacco aria	GAS	3/8"
Lunghezza tubo	m	15+1
Pressione massima	Bar	15



1901BM/8

019010111

~~€ 202,00~~
€ 117,00



3,5 kg



Avvolgitubo automatico corpo in materiale plastico antiurto per aria compressa o acqua fredda

- Pressione di utilizzo max 12 Bar
- Tubo in poliuretano da 9+1 metri, Ø 8 mm

Attacco aria	GAS	1/4"
Lunghezza tubo	m	9+1
Pressione massima	Bar	12

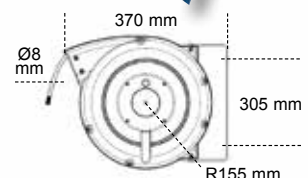

Scarpe in pelle idrorepellente con lamina antiperforazione

- Puntale in acciaio
- Lamina antiperforazione in acciaio elastico

7241C

~~€ 39,00~~
€ 22,30



EU	UK	Art.
35	2,5	072410535
36	3,5	072410536
37	4,5	072410537
38	5	072410538
39	6	072410539
40	6,5	072410540
41	7	072410541
42	8	072410542
43	9	072410543
44	10	072410544
45	10,5	072410545
46	11	072410546
47	12	072410547
48	13	072410548



BASSA

EN ISO 20345 2011

S3 SRC

7243C

~~€ 40,00~~
€ 22,80



Rapido sfilamento

EU	UK	Art.
35	2,5	072430335
36	3,5	072430336
37	4,5	072430337
38	5	072430338
39	6	072430339
40	6,5	072430340
41	7	072430341
42	8	072430342
43	9	072430343
44	10	072430344
45	10,5	072430345
46	11	072430346
47	12	072430347
48	13	072430348



ALTA

EN ISO 20345 2011

S3 RS SRC

7246B

~~€ 39,50~~
€ 22,50

Scarpe in pelle scamosciata, traforate

- Puntale in acciaio
- Lamina antiperforazione in acciaio elastico

EU	UK	Art.
35	2,5	072460235
36	3,5	072460236
37	4,5	072460237
38	5	072460238
39	6	072460239
40	6,5	072460240
41	7	072460241
42	8	072460242
43	9	072460243
44	10	072460244
45	10,5	072460245
46	11	072460246
47	12	072460247
48	13	072460248



EN ISO 20345 2011

S1P SRC

7245B

~~€ 46,50~~
€ 26,50

Scarpe "saldatore" stringate in pelle idrorepellente con rapido sfilamento e protezione frontale con chiusura a strappo

- Puntale in acciaio
- Lamina antiperforazione in acciaio elastico

EU	UK	Art.
35	2,5	072450235
36	3,5	072450236
37	4,5	072450237
38	5	072450238
39	6	072450239
40	6,5	072450240
41	7	072450241
42	8	072450242
43	9	072450243
44	10	072450244
45	10,5	072450245
46	11	072450246
47	12	072450247
48	13	072450248



Rapido sfilamento



EN ISO 20345 2011

S3 RS SRC

Scarpe in pelle scamosciata con inserti in mesh

- Puntale in Acciaio
- Lamina antiperforazione in acciaio elastico

Calzature di sicurezza

7248G

~~€ 48,00~~
€ 27,50



EU	UK	
35	2,5	072480135
36	3,5	072480136
37	4,5	072480137
38	5	072480138
39	6	072480139
40	6,5	072480140
41	7	072480141
42	8	072480142
43	9	072480143
44	10	072480144
45	10,5	072480145
46	11	072480146
47	12	072480147
48	13	072480148

BASSA



7249G

~~€ 49,50~~
€ 28,20



EU	UK	
35	2,5	072490135
36	3,5	072490136
37	4,5	072490137
38	5	072490138
39	6	072490139
40	6,5	072490140
41	7	072490141
42	8	072490142
43	9	072490143
44	10	072490144
45	10,5	072490145
46	11	072490146
47	12	072490147
48	13	072490148

ALTA



**EN ISO
20345
2011**

S1P SRC

novità

Scarpe in action nabuk idrorepellente con inserti in nylon

- Puntale in acciaio • Lamina antiperforazione in acciaio elastico

7235B

~~€ 59,00~~
€ 33,90



EU	UK	
35	2,5	072350235
36	3,5	072350236
37	4,5	072350237
38	5	072350238
39	6	072350239
40	6,5	072350240
41	7	072350241
42	8	072350242
43	9	072350243
44	10	072350244
45	10,5	072350245
46	11	072350246
47	12	072350247
48	13	072350248

BASSA



7236B

~~€ 61,50~~
€ 35,50



EU	UK	
35	2,5	072360235
36	3,5	072360236
37	4,5	072360237
38	5	072360238
39	6	072360239
40	6,5	072360240
41	7	072360241
42	8	072360242
43	9	072360243
44	10	072360244
45	10,5	072360245
46	11	072360246
47	12	072360247
48	13	072360248

ALTA



**EN ISO
20345
2011**

S3 SRC

Scarpe in pelle idrorepellente con inserti in nylon, copripuntale di rinforzo in poliuretano ed inserto rifrangente sul tallone

- Puntale in acciaio • Lamina antiperforazione in fibra composita

7220PE

~~€ 48,00~~
€ 27,90



EU	UK	
35	2,5	072200135
36	3,5	072200136
37	4,5	072200137
38	5	072200138
39	6	072200139
40	6,5	072200140
41	7	072200141
42	8	072200142
43	9	072200143
44	10	072200144
45	10,5	072200145
46	11	072200146
47	12	072200147
48	13	072200148

BASSA



EN ISO 20345 2011

S3 SRC

7221PE

~~€ 49,50~~
€ 28,90

Rapido sfilamento



EU	UK	
35	2,5	072210135
36	3,5	072210136
37	4,5	072210137
38	5	072210138
39	6	072210139
40	6,5	072210140
41	7	072210141
42	8	072210142
43	9	072210143
44	10	072210144
45	10,5	072210145
46	11	072210146
47	12	072210147
48	13	072210148

ALTA



EN ISO 20345 2011

S3 RS SRC

Sebring

novità

7224PE

~~€ 50,00~~
€ 29,00



EU	UK	
35	2,5	072240135
36	3,5	072240136
37	4,5	072240137
38	5	072240138
39	6	072240139
40	6,5	072240140
41	7	072240141
42	8	072240142
43	9	072240143
44	10	072240144
45	10,5	072240145
46	11	072240146
47	12	072240147
48	13	072240148

Scarpe in pelle scamosciata traforata con inserti in nylon, copripuntale di rinforzo in poliuretano ed inserto rifrangente sul tallone

- Puntale in acciaio
- Lamina antiperforazione in fibra composita



EN ISO 20345 2011

S1P SRC

Jarama

7310BKK

~~€ 99,00~~
€ 56,50

Rapido sfilamento



EU	UK	
38	5	073100238
39	6	073100239
40	6,5	073100240
41	7	073100241
42	8	073100242
43	9	073100243
44	10	073100244
45	10,5	073100245
46	11	073100246
47	12	073100247

Scarpe "saldatore" stringate in pelle pieno fiore idrorepellente con rapido sfilamento e protezione frontale con chiusura a strappo.

Suola in gomma ad alta resistenza

- Puntale in acciaio
- Lamina antiperforazione in fibra composita



EN ISO 20345 2011

S3 RS HRO SRC

novità

Scarpe in pelle pieno fiore idrorepellente con inserti in pelle scamosciata idrorepellente

- Puntale in composito
- Lamina antiperforazione in fibra composita

7200PN

~~€ 68,00~~
€ 38,90

EU	UK	
35	2,5	072000535
36	3,5	072000536
37	4,5	072000537
38	5	072000538
39	6	072000539
40	6,5	072000540
41	7	072000541
42	8	072000542
43	9	072000543
44	10	072000544
45	10,5	072000545
46	11	072000546
47	12	072000547
48	13	072000548

720IPN

~~€ 70,00~~
€ 39,90

EU	UK	
35	2,5	072010535
36	3,5	072010536
37	4,5	072010537
38	5	072010538
39	6	072010539
40	6,5	072010540
41	7	072010541
42	8	072010542
43	9	072010543
44	10	072010544
45	10,5	072010545
46	11	072010546
47	12	072010547
48	13	072010548

Rapido
sfilamento



BASSA

EN ISO
20345
2011

S3 SRC



Imola



ALTA

EN ISO
20345
2011

S3 RS SRC



novità

Scarpe in pelle scamosciata traforata

- Puntale in composito
- Lamina antiperforazione in fibra composita

7210PB

~~€ 63,00~~
€ 35,90

EU	UK	
35	2,5	072100435
36	3,5	072100436
37	4,5	072100437
38	5	072100438
39	6	072100439
40	6,5	072100440
41	7	072100441
42	8	072100442
43	9	072100443
44	10	072100444
45	10,5	072100445
46	11	072100446
47	12	072100447
48	13	072100448

Misano



EN ISO
20345
2011

S1P SRC

721IPG

~~€ 63,00~~
€ 35,90

EU	UK	
35	2,5	072110435
36	3,5	072110436
37	4,5	072110437
38	5	072110438
39	6	072110439
40	6,5	072110440
41	7	072110441
42	8	072110442
43	9	072110443
44	10	072110444
45	10,5	072110445
46	11	072110446
47	12	072110447
48	13	072110448

Mugello

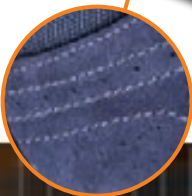

Scarpe in pelle scamosciata con inserti in nylon mesh e PU

- Puntale in fibra di vetro
- Lamina antiperforazione in fibra composita

7313G

~~€ 74,00~~
€ 42,20

EU	UK	
35	2,5	073130635
36	3,5	073130636
37	4,5	073130637
38	5	073130638
39	6	073130639
40	6,5	073130640
41	7	073130641
42	8	073130642
43	9	073130643
44	10	073130644
45	10,5	073130645
46	11	073130646
47	12	073130647
48	13	073130648



EN ISO 20345 2011

S1P SRC

7313B

~~€ 74,00~~
€ 42,20

EU	UK	
35	2,5	073130835
36	3,5	073130836
37	4,5	073130837
38	5	073130838
39	6	073130839
40	6,5	073130840
41	7	073130841
42	8	073130842
43	9	073130843
44	10	073130844
45	10,5	073130845
46	11	073130846
47	12	073130847
48	13	073130848



Monza

novità

7316N

~~€ 85,00~~
€ 48,50

EU	UK	
35	2,5	073160535
36	3,5	073160536
37	4,5	073160537
38	5	073160538
39	6	073160539
40	6,5	073160540
41	7	073160541
42	8	073160542
43	9	073160543
44	10	073160544
45	10,5	073160545
46	11	073160546
47	12	073160547
48	13	073160548



EN ISO 20345 2011

S3 SRC

novità

7323M

~~€ 89,00~~
€ 50,90

EU	UK	
35	2,5	073230335
36	3,5	073230336
37	4,5	073230337
38	5	073230338
39	6	073230339
40	6,5	073230340
41	7	073230341
42	8	073230342
43	9	073230343
44	10	073230344
45	10,5	073230345
46	11	073230346
47	12	073230347
48	13	073230348

Scarpe alte in pelle scamosciata idrorepellente con inserto in microfibra

- Puntale in fibra di vetro
- Lamina antiperforazione in fibra composita

Scarpe in pelle scamosciata idrorepellente con inserto in microfibra

- Puntale in fibra di vetro
- Lamina antiperforazione in fibra composita



Assen

Estoril

Sepang

Scarpe in pelle scamosciata con inserti in nylon

• Puntale in composito • Lamina antiperforazione in fibra composita

7250NKK

~~€ 93,00~~
€ 53,00

EU	UK	
38	5	072500238
39	6	072500239
40	6,5	072500240
41	7	072500241
42	8	072500242
43	9	072500243
44	10	072500244
45	10,5	072500245
46	11	072500246
47	12	072500247



BASSA



EN ISO 20345 2011

7251NKK

~~€ 98,00~~
€ 55,90

EU	UK	
38	5	072510238
39	6	072510239
40	6,5	072510240
41	7	072510241
42	8	072510242
43	9	072510243
44	10	072510244
45	10,5	072510245
46	11	072510246
47	12	072510247



ALTA

S1P SRC

Le Mans

Scarpe in pelle scamosciata idrorepellente con inserti in nylon idrorepellente

• Puntale in composito • Lamina antiperforazione in fibra composita

7258NKK

~~€ 97,00~~
€ 55,30

EU	UK	
38	5	072580138
39	6	072580139
40	6,5	072580140
41	7	072580141
42	8	072580142
43	9	072580143
44	10	072580144
45	10,5	072580145
46	11	072580146
47	12	072580147



BASSA



EN ISO 20345 2011

7259NKK

~~€ 101,00~~
€ 57,50

EU	UK	
38	5	072590138
39	6	072590139
40	6,5	072590140
41	7	072590141
42	8	072590142
43	9	072590143
44	10	072590144
45	10,5	072590145
46	11	072590146
47	12	072590147



ALTA

S3 SRC

Scarpe in pelle nabuk idrorepellente con inserti in microfibra idrorepellente

- Puntale in materiale composito
- Lamina antiperforazione in fibra composita

Zolder

7252NKK

~~€ 112,00~~
€ 63,90



EU	UK	
38	5	072520138
39	6	072520139
40	6,5	072520140
41	7	072520141
42	8	072520142
43	9	072520143
44	10	072520144
45	10,5	072520145
46	11	072520146
47	12	072520147

BASSA



7253NKK

~~€ 114,00~~
€ 65,00



EU	UK	
38	5	072530138
39	6	072530139
40	6,5	072530140
41	7	072530141
42	8	072530142
43	9	072530143
44	10	072530144
45	10,5	072530145
46	11	072530146
47	12	072530147

ALTA



EN ISO 20345 2011

S3 SRC

Scarpe in pelle Nabuk ingrassata idrorepellente con inserto antiabrasione in microfibra e suola in gomma ad alta resistenza.

- Puntale in alluminio • Lamina antiperforazione in fibra composita
- Supporto per il contenimento laterale della caviglia

Daytona

7293NG

~~€ 127,00~~
€ 72,50



EU	UK	
38	5	072930438
39	6	072930439
40	6,5	072930440
41	7	072930441
42	8	072930442
43	9	072930443
44	10	072930444
45	10,5	072930445
46	11	072930446
47	12	072930447
48	13	072930448

7294NG

~~€ 131,00~~
€ 74,50



EU	UK	
38	5	072940438
39	6	072940439
40	6,5	072940440
41	7	072940441
42	8	072940442
43	9	072940443
44	10	072940444
45	10,5	072940445
46	11	072940446
47	12	072940447
48	13	072940448



EN ISO 20345 2011

S3 HRO SRC



7849BL

~~€ 32,50~~
€ 18,50

Giacca da lavoro

- T/C Twill, 65% poliestere, 35% cotone, 245 g

XS	078490100
S	078490101
M	078490102
L	078490103
XL	078490104
XXL	078490105
XXXL	078490106
XXXXL	078490107



- Fascia in vita elasticizzata per una migliore vestibilità



- Polsini regolabili con bottoni automatici



- Tasca destra al petto con inserti porta penne o piccoli utensili

- Chiusura frontale con zip, coperta da patta con chiusura a strappo
- Tasca sinistra al petto con chiusura a strappo, dotata di inserto porta badge
- Due Ampie tasche in vita
- Due tasche interne

7840BL

~~€ 30,00~~
€ 17,00

Pantaloni da lavoro

- T/C Twill, 65% poliestere, 35% cotone, 245 g

XS	078400100
S	078400101
M	078400102
L	078400103
XL	078400104
XXL	078400105
XXXL	078400106
XXXXL	078400107



- Tascone laterale sinistro con chiusura a strappo ed inserto porta badge



- Fascia porta martello



- Vita elasticizzata ai lati
- Due tasche posteriori con chiusura a strappo

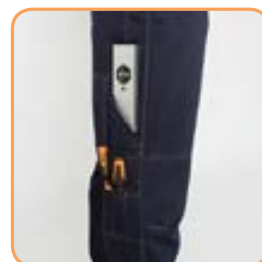

- Tasca porta metro con inserti porta penne o piccoli utensili

- Triple cuciture nei punti di maggiore usura
- Chiusura metal zip
- Due ampie tasche anteriori

7905E

~~€ 72,00~~
€ 41,00

Tuta da lavoro

• In T/C Canvas,
65% poliestere,
35% cotone,
260 g



XS	079050900
S	079050901
M	079050902
L	079050903
XL	079050904
XXL	079050905
XXXL	079050906
XXXXL	079050907

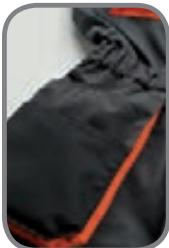

7900E

~~€ 46,00~~
€ 26,00

Pantaloni da lavoro multitasche

• In T/C Canvas,
65% poliestere,
35% cotone, 260 g



XS	079000900
S	079000901
M	079000902
L	079000903
XL	079000904
XXL	079000905
XXXL	079000906
XXXXL	079000907

7903E

~~€ 57,00~~
€ 32,50

Salopette da lavoro

• In T/C Canvas,
65% poliestere,
35% cotone, 260 g



XS	079030900
S	079030901
M	079030902
L	079030903
XL	079030904
XXL	079030905
XXXL	079030906
XXXXL	079030907

7901E

~~€ 37,00~~
€ 21,00

Bermuda da lavoro

• In T/C Canvas, 65% poliestere,
35% cotone, 260 g



XS	079010900
S	079010901
M	079010902
L	079010903
XL	079010904
XXL	079010905
XXXL	079010906
XXXXL	079010907

7907E

~~€ 42,50~~
€ 24,50

Gilet multitasche da lavoro

• In T/C Canvas,
65% poliestere,
35% cotone, 260 g



XS	079070900
S	079070901
M	079070902
L	079070903
XL	079070904
XXL	079070905
XXXL	079070906
XXXXL	079070907

7909E

~~€ 50,50~~
€ 28,90

Giacca da lavoro

• In T/C Canvas, 65% poliestere,
35% cotone, 260 g



XS	079090900
S	079090901
M	079090902
L	079090903
XL	079090904
XXL	079090905
XXXL	079090906
XXXXL	079090907

7865E

~~€ 65,50~~
€ 37,50

Tuta leggera da lavoro

• T/C twill, 65% poliestere, 35% cotone, 180 g



XS	078650900
S	078650901
M	078650902
L	078650903
XL	078650904
XXL	078650905
XXXL	078650906
XXXXL	078650907



7860E

~~€ 42,50~~
€ 24,50

Pantaloni leggeri da lavoro

• T/C twill, 65% poliestere, 35% cotone, 180 g



XS	078600900
S	078600901
M	078600902
L	078600903
XL	078600904
XXL	078600905
XXXL	078600906
XXXXL	078600907

7863E

~~€ 51,00~~
€ 29,00

Salopette leggera da lavoro

• T/C twill, 65% poliestere, 35% cotone, 180 g



XS	078630900
S	078630901
M	078630902
L	078630903
XL	078630904
XXL	078630905
XXXL	078630906
XXXXL	078630907

7861E

~~€ 35,00~~
€ 19,90

Bermuda leggeri da lavoro

• T/C twill, 65% poliestere, 35% cotone, 180 g



XS	078610900
S	078610901
M	078610902
L	078610903
XL	078610904
XXL	078610905
XXXL	078610906
XXXXL	078610907

7867E

~~€ 39,00~~
€ 22,20

Gilet multitasche leggero da lavoro

• T/C twill, 65% poliestere, 35% cotone, 180 g



XS	078670900
S	078670901
M	078670902
L	078670903
XL	078670904
XXL	078670905
XXXL	078670906
XXXXL	078670907

7869E

~~€ 45,50~~
€ 25,90

Giacca leggera da lavoro

• T/C twill, 65% poliestere, 35% cotone, 180 g



XS	078690900
S	078690901
M	078690902
L	078690903
XL	078690904
XXL	078690905
XXXL	078690906
XXXXL	078690907

7875E

~~€ 65,50~~
€ 37,50

Tuta leggera da lavoro

- T/C twill, 65% poliestere, 35% cotone, 180 g



XS	078750900
S	078750901
M	078750902
L	078750903
XL	078750904
XXL	078750905
XXXL	078750906
XXXXL	078750907

7870E

~~€ 42,50~~
€ 24,50

Pantaloni leggeri da lavoro

- T/C twill, 65% poliestere, 35% cotone, 180 g



XS	078700900
S	078700901
M	078700902
L	078700903
XL	078700904
XXL	078700905
XXXL	078700906
XXXXL	078700907

7873E

~~€ 51,00~~
€ 29,00

Salopette leggera da lavoro

- T/C twill, 65% poliestere, 35% cotone, 180 g



XS	078730900
S	078730901
M	078730902
L	078730903
XL	078730904
XXL	078730905
XXXL	078730906
XXXXL	078730907

7871E

~~€ 35,00~~
€ 19,90

Bermuda leggeri da lavoro

- T/C twill, 65% poliestere, 35% cotone, 180 g



XS	078710900
S	078710901
M	078710902
L	078710903
XL	078710904
XXL	078710905
XXXL	078710906
XXXXL	078710907

7877E

~~€ 39,00~~
€ 22,20

Gilet multitasche leggero da lavoro

- T/C twill, 65% poliestere, 35% cotone, 180 g



XS	078770900
S	078770901
M	078770902
L	078770903
XL	078770904
XXL	078770905
XXXL	078770906
XXXXL	078770907

7879E

~~€ 45,50~~
€ 25,90

Giacca leggera da lavoro

- T/C twill, 65% poliestere, 35% cotone, 180 g



XS	078790900
S	078790901
M	078790902
L	078790903
XL	078790904
XXL	078790905
XXXL	078790906
XXXXL	078790907

7816G

~~€ 58,00~~
€ 33,50

Pantaloni da lavoro multitasche

- T/C Canvas, 65% poliestere, 35% cotone, 260 g
- Tasche per ginocchiere e fondo gamba rinforzati in poliestere 600D

XS	078160000
S	078160001
M	078160002
L	078160003
XL	078160004
XXL	078160005
XXXL	078160006



- Vita più alta nella parte posteriore per maggiore protezione della schiena
- Inserto posteriore elasticizzato per facilitare i movimenti
- Vita elasticizzata ai lati
- Anello per portachiavi in vita



- Ampie tasche laterali con chiusura a bottoni automatici, una dotata di inserto portabadge



- Cavallo antistrappo

novità

7816BL

~~€ 58,00~~
€ 33,50

Pantaloni da lavoro multitasche blu.

- T/C Canvas, 260 g

XS	078160100
S	078160101
M	078160102
L	078160103
XL	078160104
XXL	078160105
XXXL	078160106



7815N

~~€ 74,50~~
€ 42,50

Pantaloni da lavoro multitasche

- T/C canvas ritorto, 65% poliestere, 35% cotone, 280 g

XS	078150000
S	078150001
M	078150002
L	078150003
XL	078150004
XXL	078150005
XXXL	078150006

YKK

Little Parts. Big Difference.



7526

~~€ 56,50~~
€ 32,20

Jeans da lavoro elasticizzati

- 68% Cotone denim, 29% poliestere, 3% tessuto elasticizzato, 10OZ
- Rinforzi in poliestere 600D all'interno delle tasche posteriori e sul fondo gamba

XS	075260046
S	075260048
M	075260050
L	075260052
XL	075260054
XXL	075260056
XXXL	075260058



- Tasca porta metro e fascia porta martello
- Due tasche posteriori
- Prelavaggio "stone washed"



• Cavallo antistrappo

7525

~~€ 49,00~~
€ 27,90

Jeans da lavoro elasticizzati

- In 68% cotone denim, 29% poliestere, 3% tessuto elasticizzato, 10 OZ

XS	075250046
S	075250048
M	075250050
L	075250052
XL	075250054
XXL	075250056
XXXL	075250058



7505M

~~€ 85,50~~
€ 48,70

Pantaloni multitasche mimetici

- In 100% cotone twill 260 g

XS	075050246
S	075050248
M	075050250
L	075050252
XL	075050254
XXL	075050256
XXXL	075050258



YKK

Little Parts. Big Difference.

YKK

Little Parts. Big Difference.

My Beta

color your work



www.beta-tools.it



Beta Utensili S.p.A.
Via Volta 18
20845 Sovico (MB)
Tel. 039.2077.1
Fax 039.2010742

www.beta-tools.it info@beta-tools.com



**Promozione valida
dal 18/01/2016
al 15/12/2016**

Le immagini sono indicative, Beta si riserva il diritto di apportare aggiornamenti e migliorie alla propria gamma produttiva senza alcun preavviso.